

Supplied by:



NEW

Surface Mount LED Aluminum Channel Model Combo30

- multi-armed connections
- simplified installation and service
- for the construction of suspended and surface luminaires
- optional up&down lighting



max 30 mm



surface



suspended

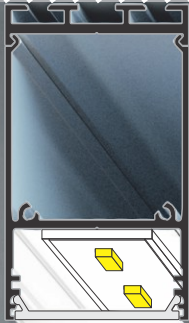

* Parameters tolerance +/- 7%

Surface Mount LED Aluminum Channel ~ Model Combo30

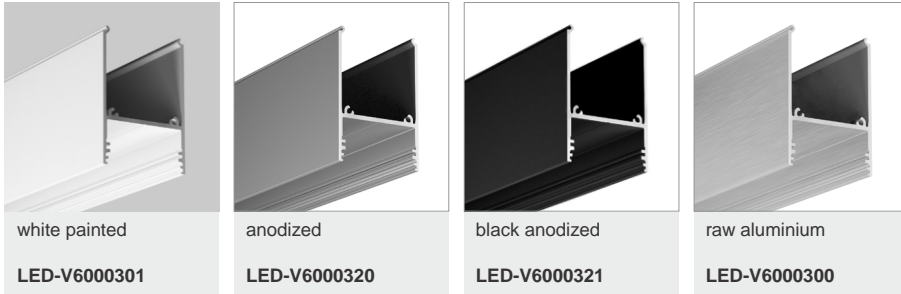
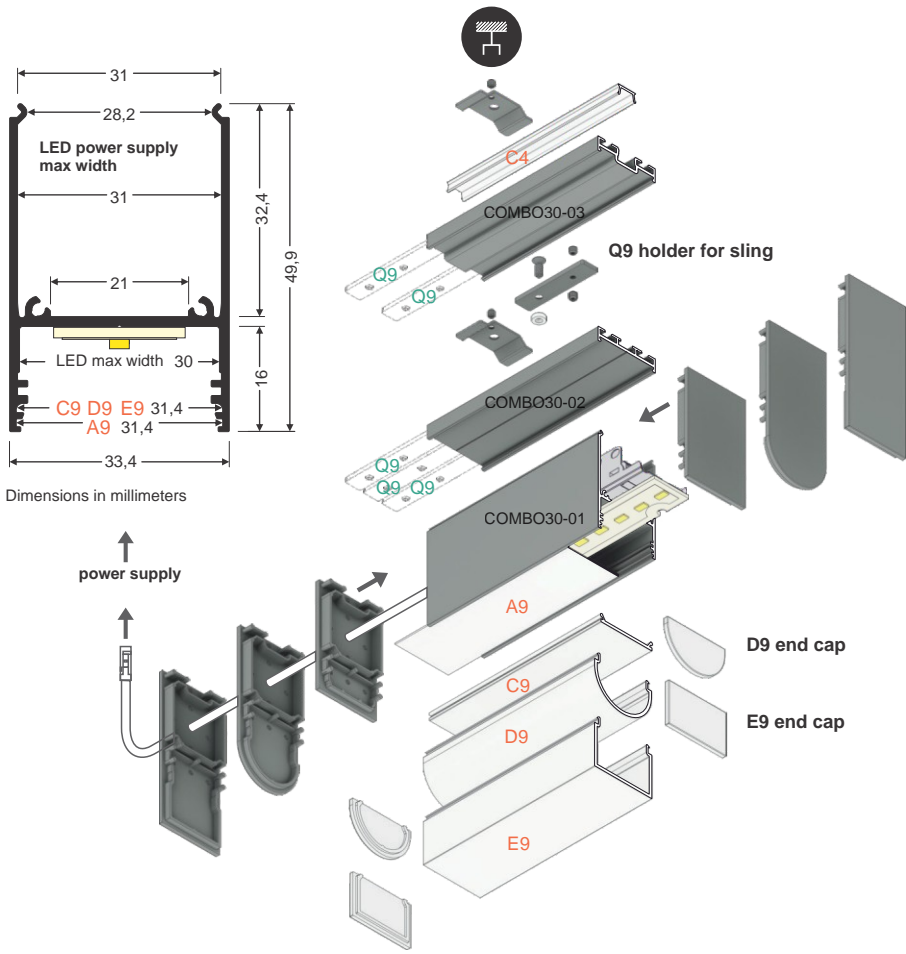

Quantities, package and other length available

COMBO30-01A end cap material: ABS	COMBO30-01A-D9 end cap material: ABS	COMBO30-01A-E9 end cap material: ABS
 White LED-V6998901	 White LED-V6999001	 White LED-V6999101
 Silver LED-V6998940	 Silver LED-V6999040	 Silver LED-V6999140
 Black LED-V6998902	 Black LED-V6999002	 Black LED-V6999102
 Gray LED-V6998922	 Gray LED-V6999022	 Gray LED-V6999122

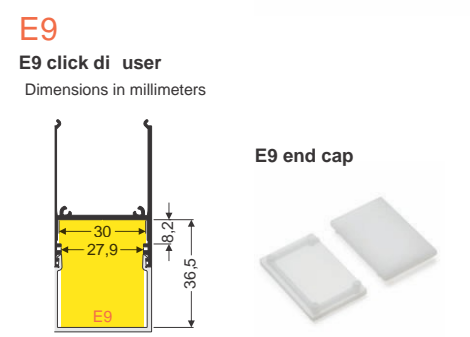
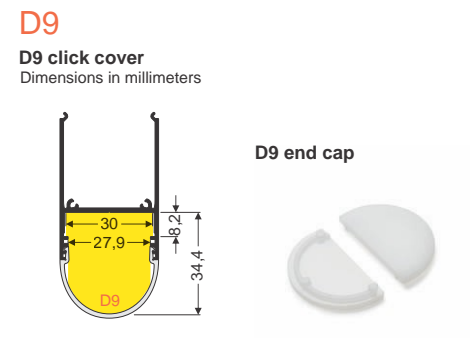
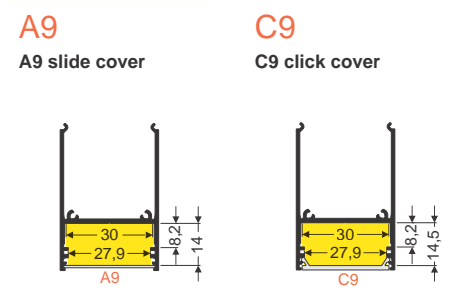
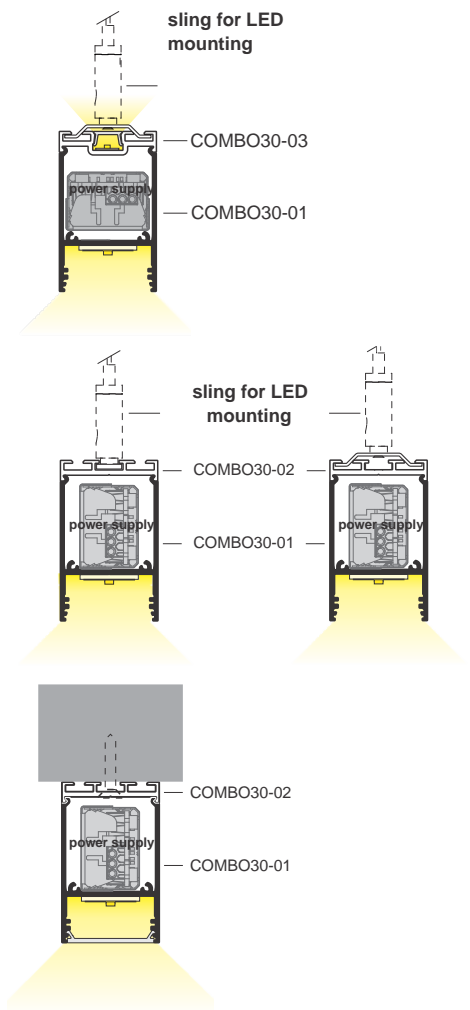

* Parameters tolerance +/- 7%

Surface Mount LED Aluminum Channel ~ Model Combo30

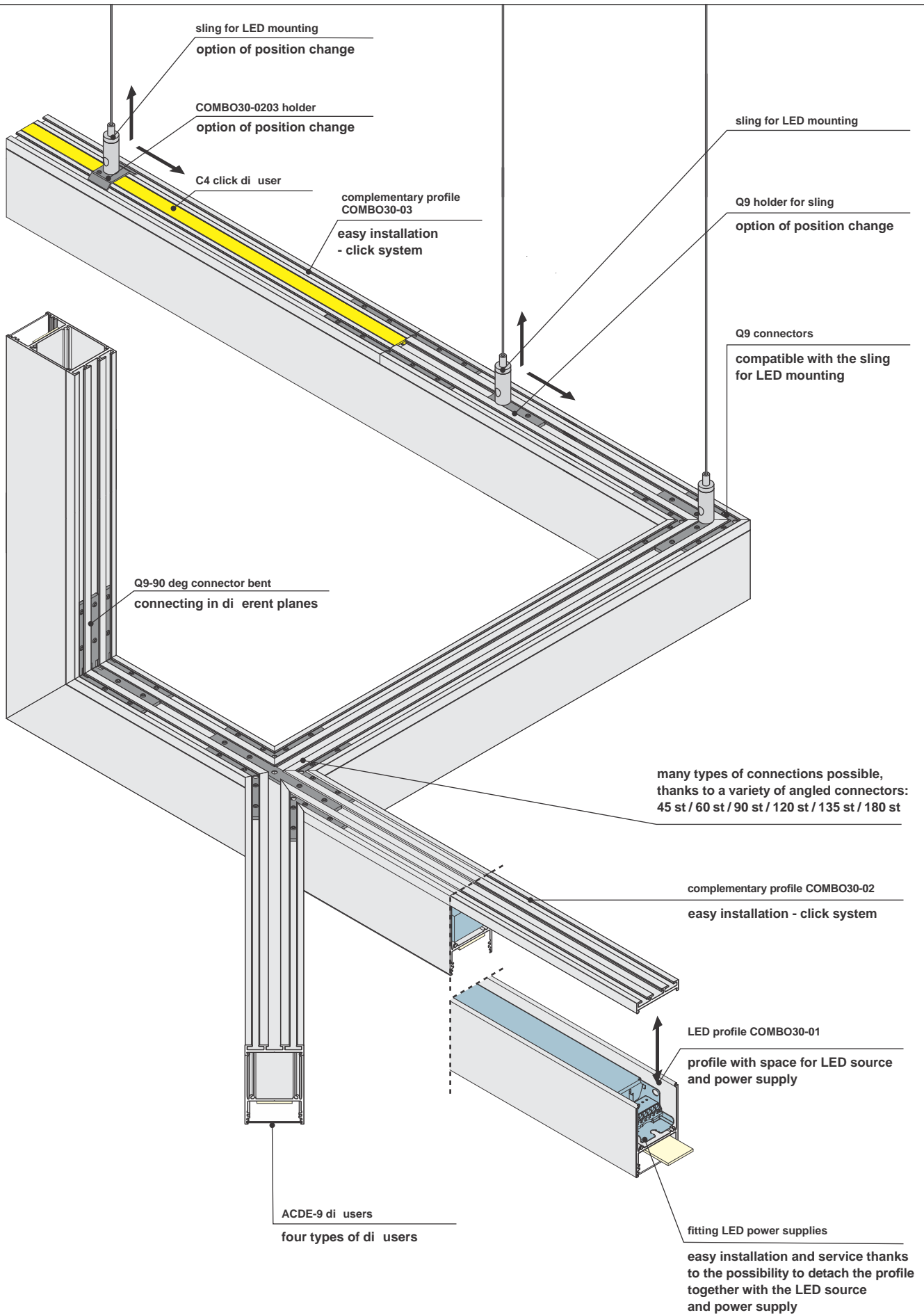

* Parameters tolerance +/- 7%

COMPLEMENTARY PROFILE COMBO30-02

Dimensions in millimeters

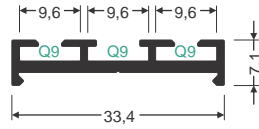

white painted
LED-V6000701

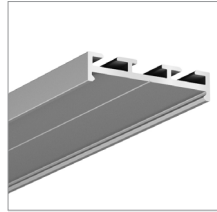

anodized
LED-V6000720

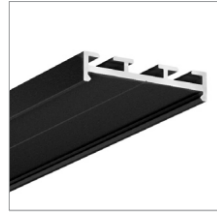

black anodized
LED-V6000721

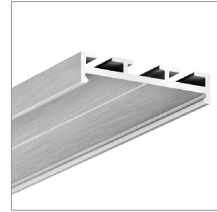

raw aluminium
LED-V6000700

INDEX = length 2000 mm
Quantities, package and other length available

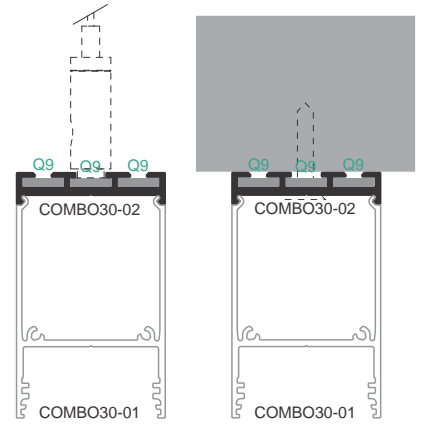

COMPLEMENTARY PROFILE COMBO30-03

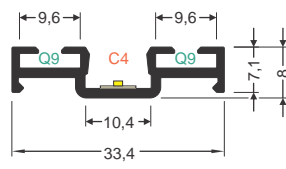

Dimensions in millimeters

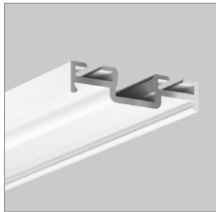

white painted
LED-V6001101

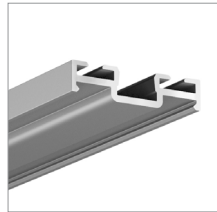

anodized
LED-V6001120

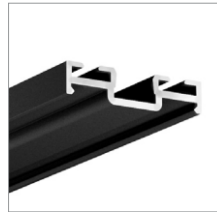

black anodized
LED-V6001121

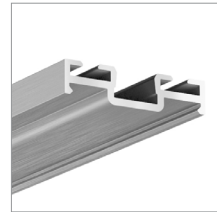

raw aluminium
LED-V6001100

Dimensions in millimeters

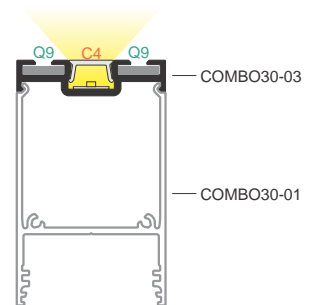
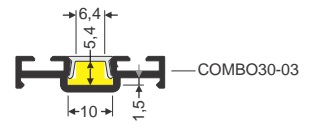

COMBO30-0203 holder material: stainless steel



inox
LED-V5998719

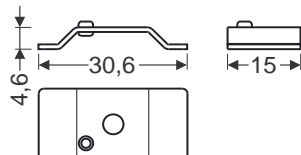

Dimensions in millimeters

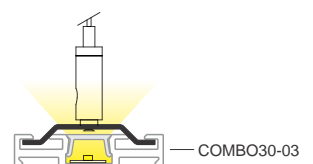
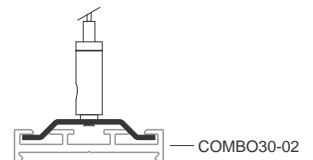

* Parameters tolerance +/- 7%

Supplied by:



MANY OPTIONS OF ANGULAR CONNECTIONS



The system of connectors and sockets in the profile allows the creation of stable multi-armed connections and the use of slings in the place of profile connections

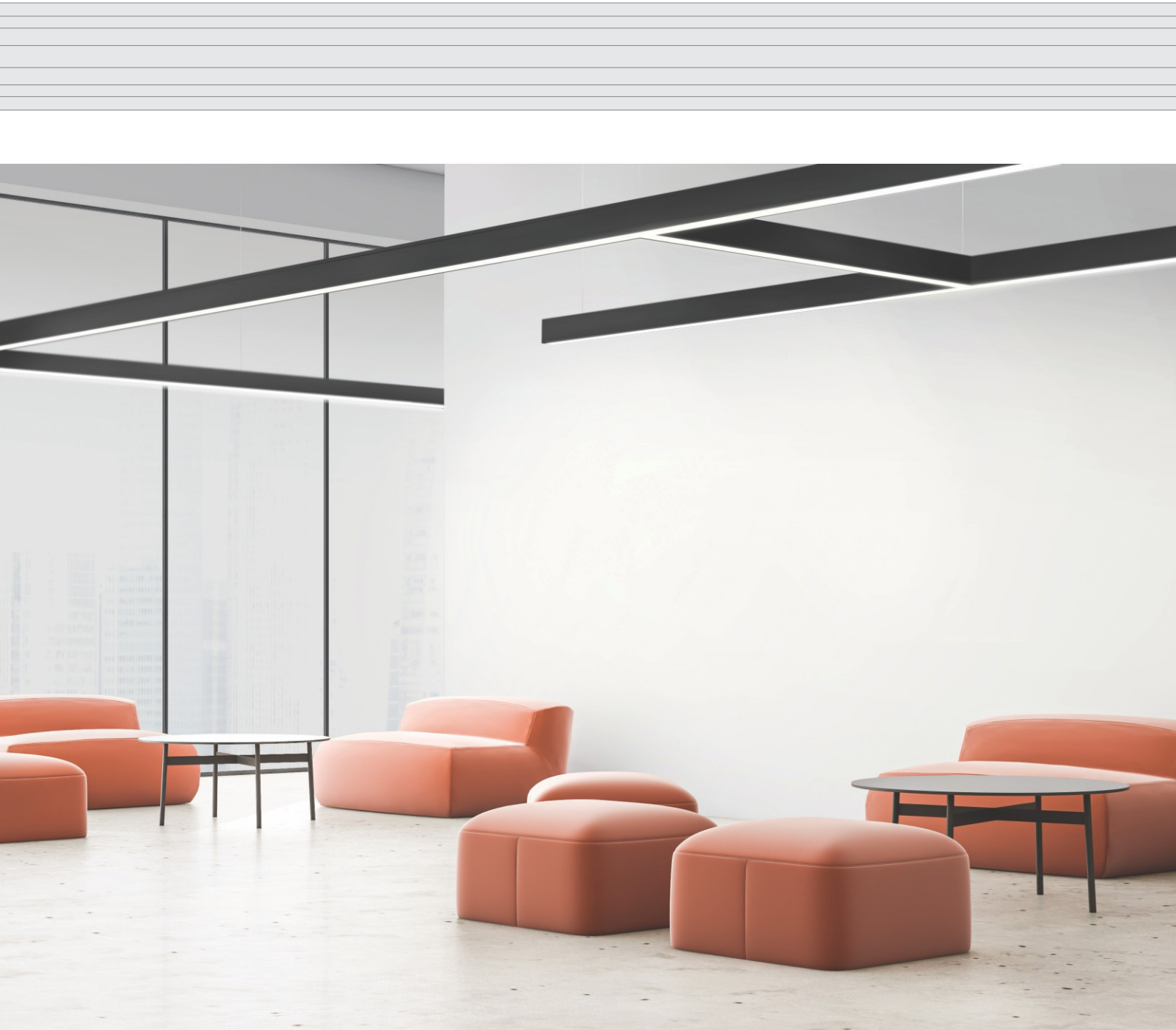

* Parameters tolerance +/- 7%

Supplied by:

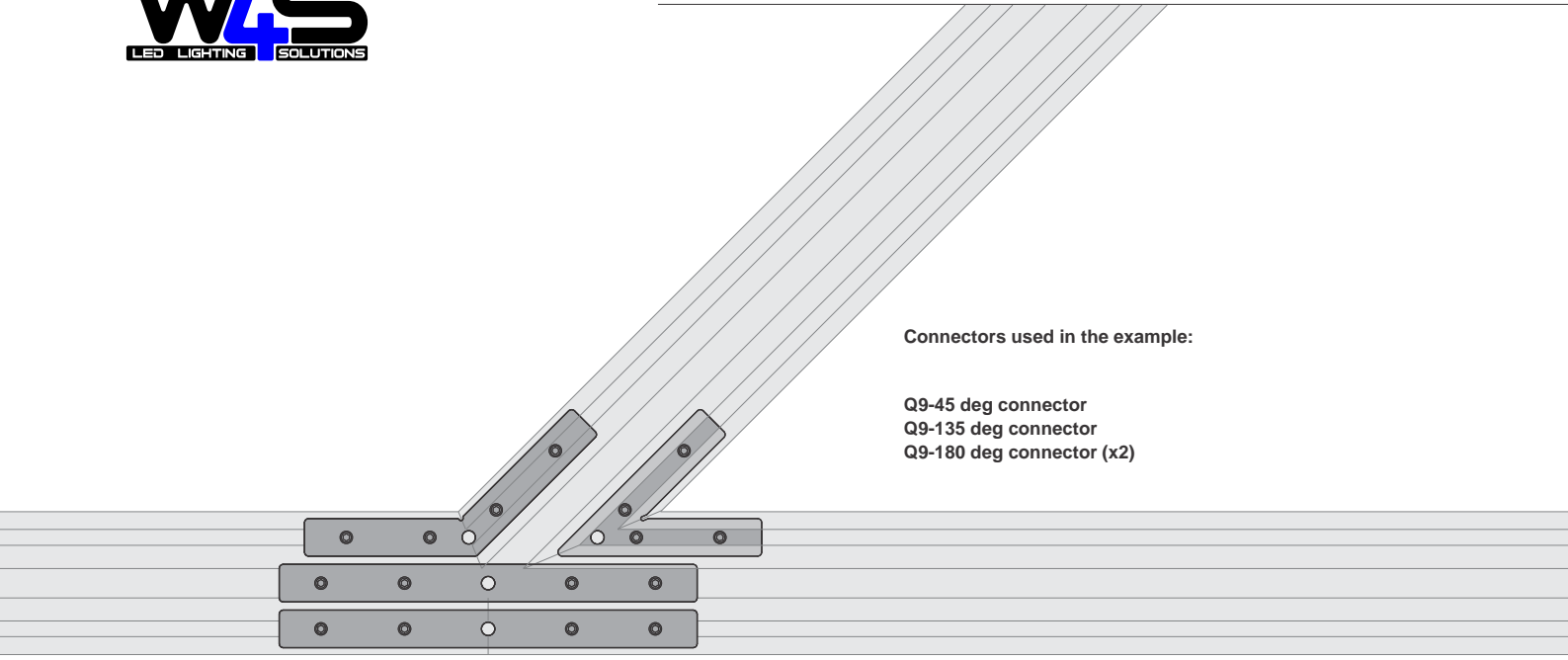

Connectors used in the example:

- Q9-45 deg connector
- Q9-135 deg connector
- Q9-180 deg connector (x2)



* Parameters tolerance +/- 7%

Covers

A9

A9 slide di user
Dimensions in millimeters

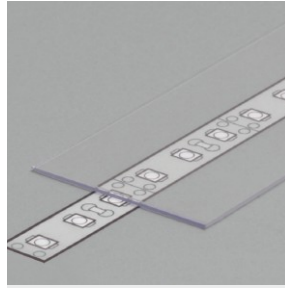
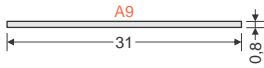

transparent material PC
LED-V3420016P

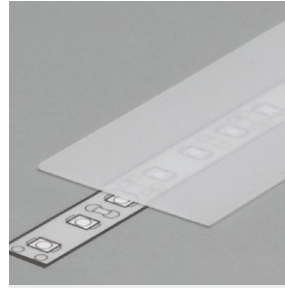

frosted material PP
LED-V3420039P

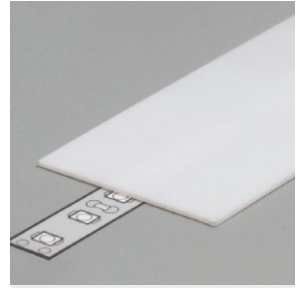

opal material PP
LED-V3420038P

C9

C9 click di user
Dimensions in millimeters

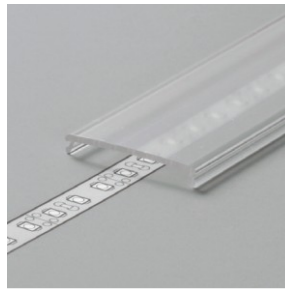
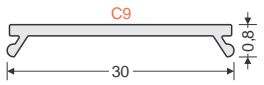

transparent material PMMA
LED-V3460016P



opal material PMMA
LED-V3460038P

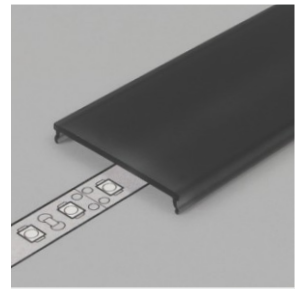

black material PMMA
LED-V3460041P

D9

D9 click di user
Dimensions in millimeters

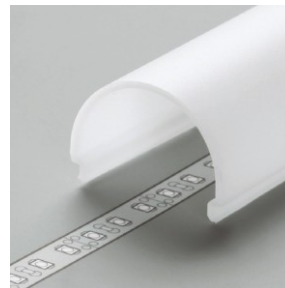
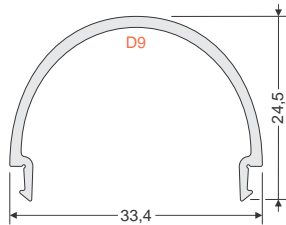

opal material PMMA
LED-C1080038P

D9 end cap

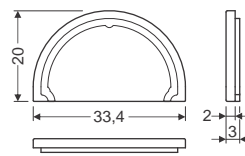

Dimensions in millimeters



opal material PMMA
C1840038

E9

E9 click di user
Dimensions in millimeters

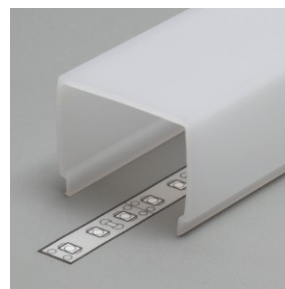
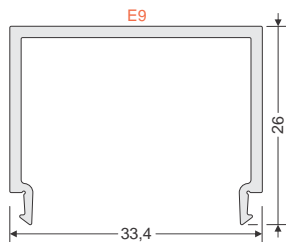

opal Material: PMMA
LED-V3540038P

E9 end cap

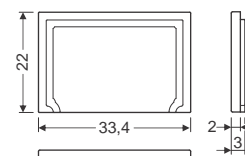

Dimensions in millimeters



opal material PMMA
V4990038



INDEX = length 2000 mm
Quantities, package and other length available

* Parameters tolerance +/- 7%

Q9 Connectors (1 piece including screws)

Q9¹

Q9-90 deg connector bent
material: zinc coated steel
 Dimensions in millimeters

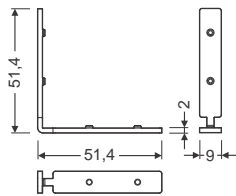

LED-V5999519s

Q9²

Q9-180 deg connector
material: zinc coated steel
 Dimensions in millimeters

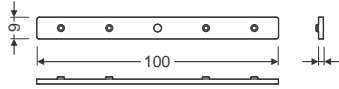

LED-V5999819s

Q9³

Q9-135 deg connector
material: zinc coated steel
 Dimensions in millimeters

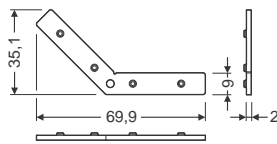

LED-V5999719s

Q9⁴

Q9-120 deg connector
material: zinc coated steel
 Dimensions in millimeters

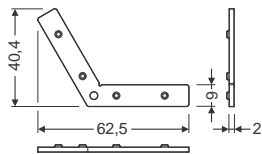

LED-V5999619s

Q9⁵

Q9-90 deg connector
material: zinc coated steel
 Dimensions in millimeters

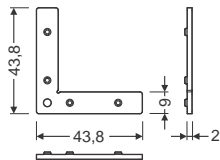

LED-V5999419s

Q9⁶

Q9-60 deg connector
material: zinc coated steel
 Dimensions in millimeters

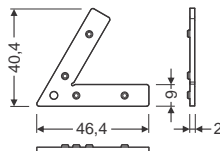

LED-V5999319s

Q9⁷

Q9-45 deg connector
material: zinc coated steel
 Dimensions in millimeters

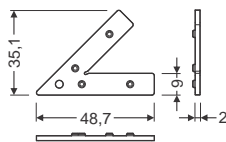

LED-V5999219s

Q9

SLINGS ELEMENTS
 Dimensions in millimeters

Q9 holder for sling
material: zinc coated steel

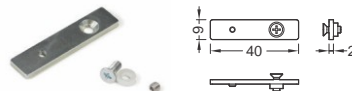

LED-V5999919s

screw for Q9 connector



LED-V5998830

* Parameters tolerance +/- 7%