



Wilo Z 15+ Domestic Hot Water Circulating Pump

Installation and Operating Instructions

WILO_IOM_Z15+_0522



Warning

- Please read over the operating manual prior to installation and keep it for reference.
- The main electrical connection to the pump must be grounded before use.
- It is strictly prohibited to touch the electrical connections of the pump while the pump is in operation.
- It is strictly prohibited to run the Z 15+ pump without water.

Contents

I. MODEL DESCRIPTION.....	1
II. TECHNICAL PARAMETERS.....	2
III. INSTALLATION PRECAUTIONS.....	2
IV. HOW TO USE (applies to models with timer only; models without timer, skip to SECTION V. FAULT ANALYSIS AND ELIMINATION)	4
V. FAULT ANALYSIS AND ELIMINATION	6

Z 15+ Circulation Pump

Version 05/2022

Thank you for choosing the WILO® Z 15+ domestic hot water recirculator pump. Please read the operating manual prior to installation and keep it for reference.

Warning

- It is strictly prohibited to touch the electric components of the pump while powered and in operation.
- It is strictly prohibited to run the pump without water.

Warning about modifying the pump without manufacturer's knowledge

- It is strictly prohibited to modify the pump from its original configuration.

I. MODEL DESCRIPTION

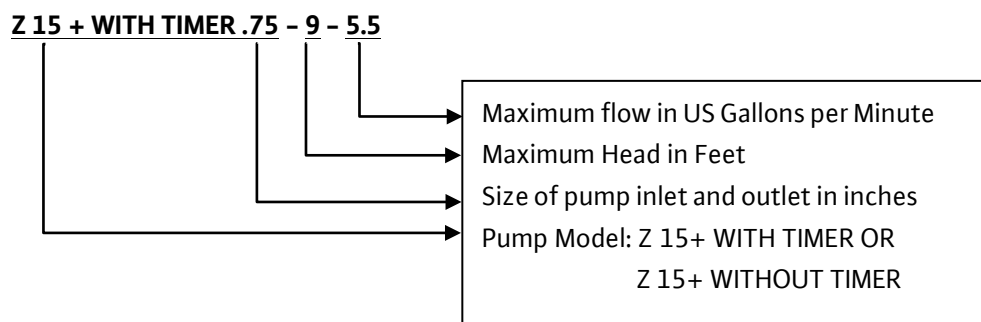

II. TECHNICAL PARAMETERS

Product model: Z 15+	Maximum flow: 5.5 US Gallons per Minute
Rated voltage: 115V	Protection class: NEMA 12
Rated frequency: 60Hz	Maximum operating pressure: 145 PSI ²
Max. input power: 30W	Maximum water temperature: 160°F ¹
Max. input current: 0.26A	Inlet thread: ¾" Female NPT
Max. Head: 9 Ft.	Outlet thread: ¾" Male NPT
Low Lead Standard: NSF-61 Listed	Pump Weight: 5.5 lbs

- Notes:
1. The minimum temperature of the water must be greater than 32°F, and the maximum temperature is 160°F.
 2. The inlet (supply) pressure must be higher than .75 PSI to work properly.

Warning on Installation instructions

- It is strongly suggested to hire a plumbing professional to install this pump into the hot-water system.

III. INSTALLATION PRECAUTIONS

For best performance and reliability, please follow the instructions in this manual.

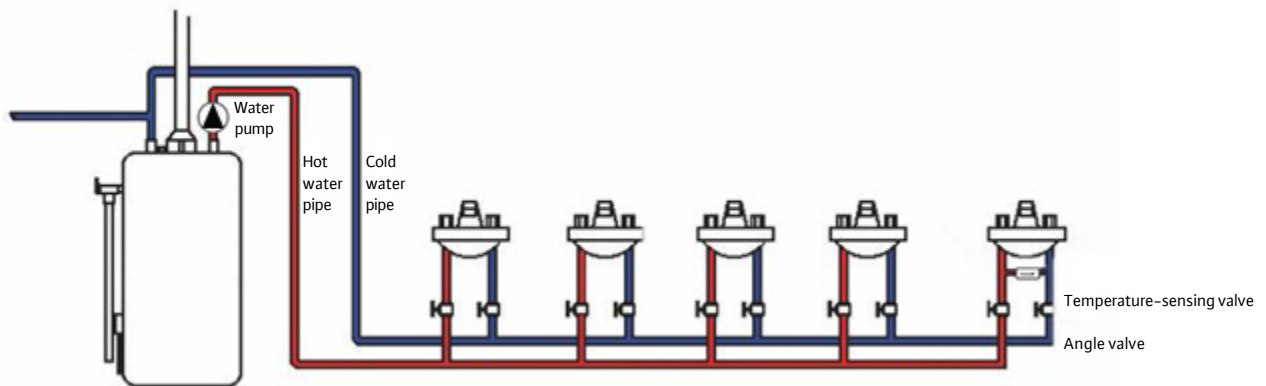

Schematic diagram of a domestic hot water system

Step 1: Carefully check system components to ensure that the components are not missing or damaged.

Scope of supply:

- One circulating pump with, or without, timing function (provided by WILO)
- One NSF-61 gasket to be placed into the union end of the pump (provided by WILO)
- Installation and operation instructions (provided by WILO)

Z 15+ Circulation Pump

Version 05/2022

Step 1: Close the gas valve or shut the power off to water heater.

Step 2: Close the supply water valve to the water heater located, in most cases, above the water heater on the cold-water inlet to the hot water heater.

Step 3: Drain the water from the hot water pipes by opening a hot water faucet in the house (at the lowest level), then open the hot water faucet at the highest level in the home to prevent a vacuum from forming. Let the water drain until it stops flowing. Drain the remaining water from hot water heater by opening the spigot (located at the bottom of the tank).

Step 4: Disconnect the hot water heater at the hot water discharge. (See below Picture).

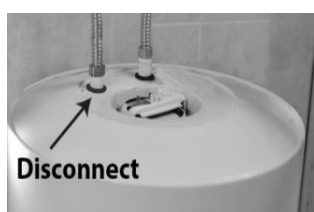

Step 5: Using the supplied gasket, insert it into the 3/4" female union fitting and install the union end into the water heater discharge line (the pump flow arrow on the side of the pump should be installed so that the pump is pumping away from the hot water heater, toward the faucets). Connect the water line (out to the faucets) to the 3/4" male NPT discharge of the pump and tighten. **NOTE:** Do not overtighten the union connection! Be sure that the pump is not touching the exhaust vent (chimney) of a gas or oil-fired hot water heater. **It is recommended to place a full-port ball valve upstream of the pump to be able to isolate the pump for servicing.**

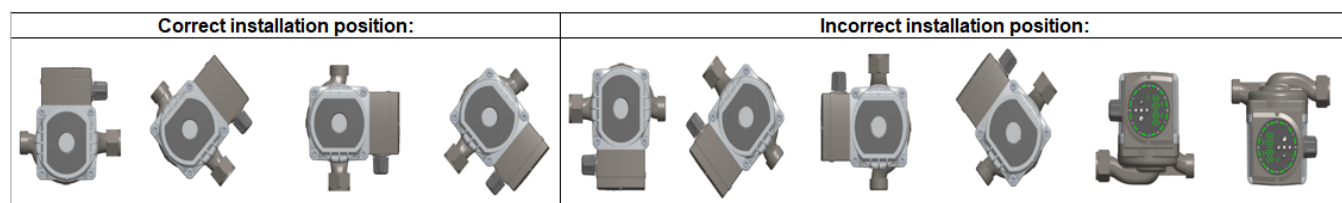

Step 6: Close faucet on the bottom of tank and lowest faucet in the house.

Step 7: Reopen the supply valve to the hot water heater and allow the water to run out of the faucet at the highest level of the house until all the air has been completely purged from the piping.

Step 8: Shut the highest faucet off after all the air has been purged.

Step 9: Reopen Gas Valve / power to water heater and restart the water heater. Please refer to manufacturer of the hot water boiler's operation manual for specific instructions.

Step 10: Plug the electrical connection into a wall outlet.

Z 15+ Circulation Pump
Version 05/2022

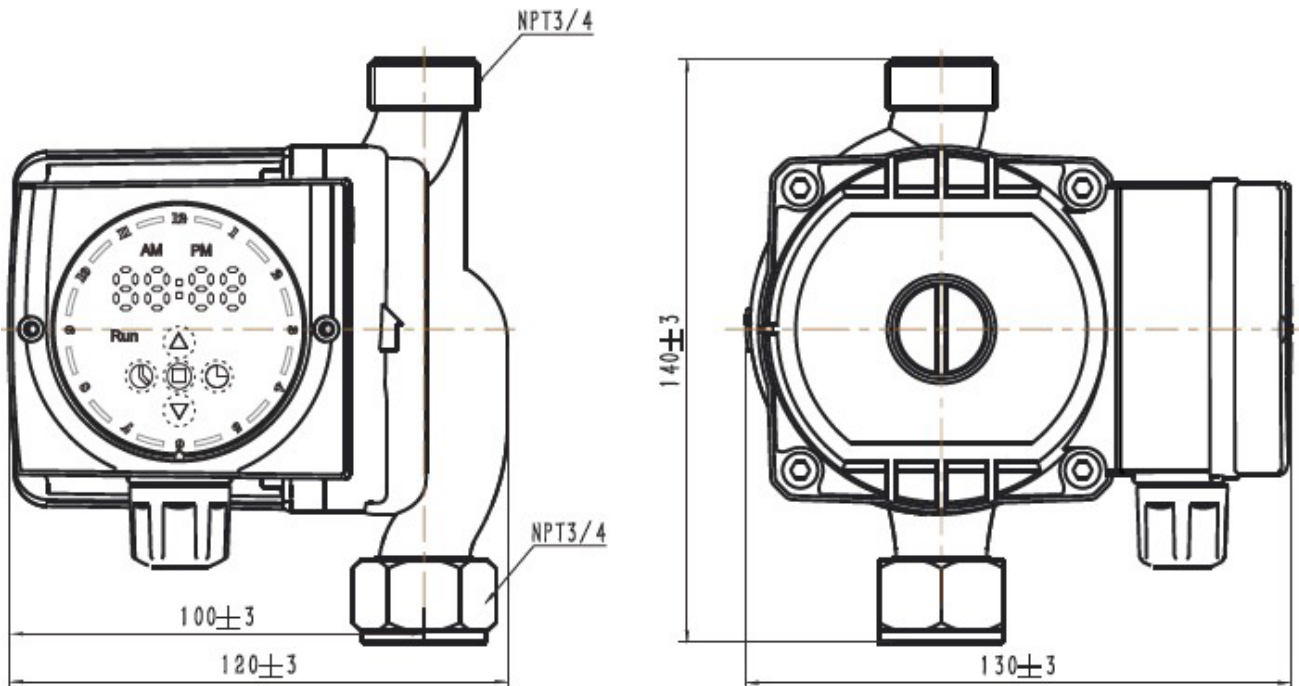

*Pump pictured with timer

Performance parameters of the product

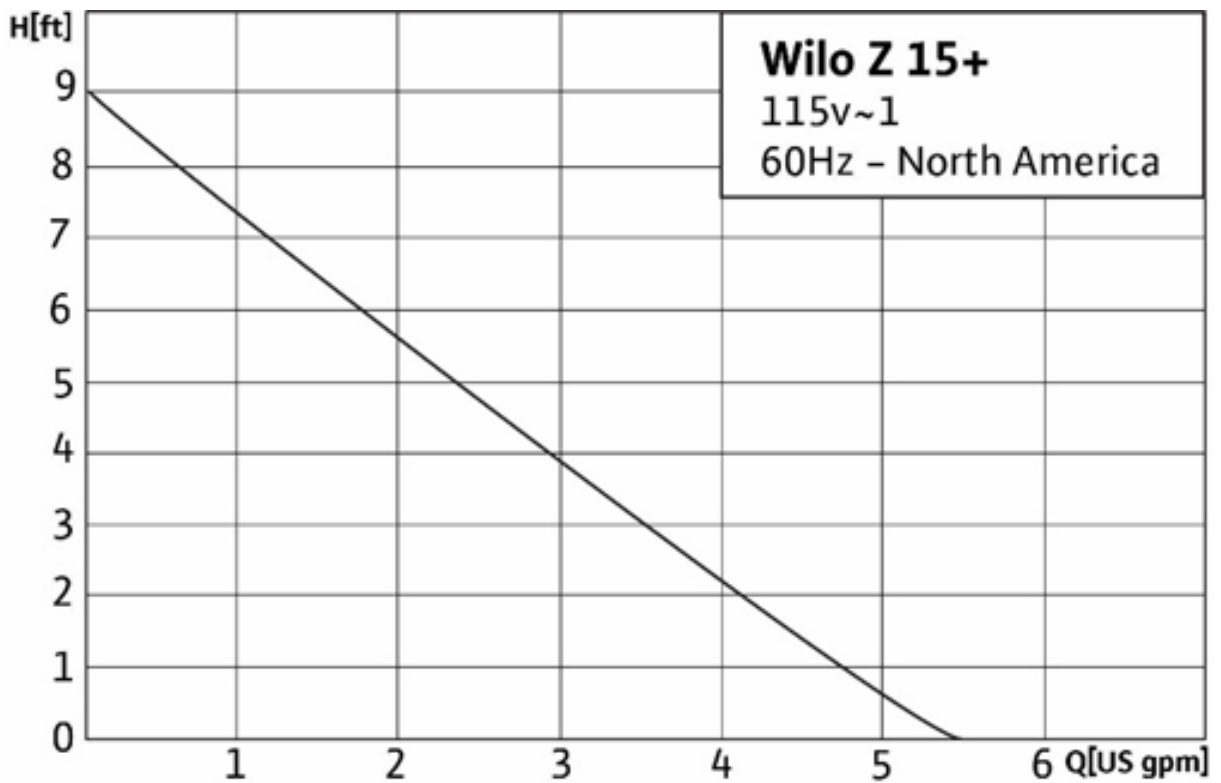

Z 15+ Circulation Pump

Version 05/2022

Function overview

Function name	Function description
Forced operation	The water pump runs continuously.
Timed operation (applies to models with timer only)	The water pump automatically runs during the set period of time. (The minimum setting period of time is 1 hour in the timing function)
Screen function (applies to models with timer only)	From 9:00 p.m. to 7:00 a.m., the display interface of water pump will enter the screen rest mode if not operated within 20s (except the running indicator lamp), and can be lit by pressing any button.

Note: The factory default mode is that the pump is started at fixed time in 24h.

IV. HOW TO USE (applies to models with timer only; models without timer, skip to SECTION V. FAULT ANALYSIS AND ELIMINATION)

1. Panel description

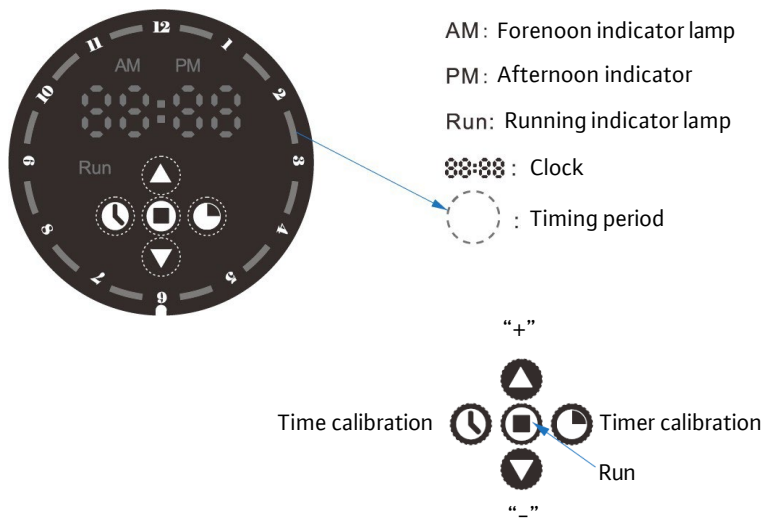

2. Debugging and menu setting:

Special Note: The timer control is designed to turn the circulator on and off at preset times, allowing the user to select operation of the circulator during high use periods of the day. If you want to set the pump working over a specific time period (the timer programming), please proceed to step 1. If you want the pump to work continuously and no timer needed, skip to Step 3(Forced operation). In case of a power outage, the timer has a battery that helps keep the time.

- ① **Time calibration:** The timer is based on the 24-hour system, and it automatically switches between AM/PM when the hour digital lamp changes from 12 to 1 in the time calibration process. Adjust the time of the pump to the current time; press the “Time calibration” key, the hour area starts flashing, press the “+/-” key to adjust the hours; press the “Run” key to acknowledge. The minute area will then flash, press the “+/-” key to adjust the minutes; exit the time calibration function by pressing the “Run” key or not operating for 20s.



- ② **Timer Calibration:** Set the running period of the pump by pressing the “Timer calibration” key. The dial indicator lamp will start flashing, and press the “+/-” key to adjust the cursor to the target time period; (the timer is based on the 24-hour system, and it automatically switches between AM/PM when the cursor passes through the 12 o’clock) Press the “Run” key to turn on or off the current time period; exit the timer calibration function by pressing the “Timer calibration” key or not operating for 20s.



- ③ **Forced operation:** Press the “Run” key, the set time goes off, and the pump runs automatically and continuously.

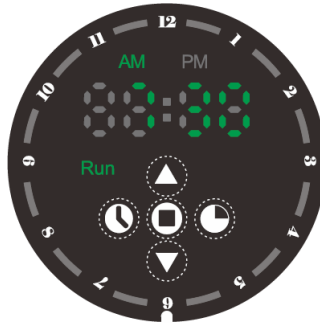

I. FAULT ANALYSIS AND ELIMINATION

Fault	Main causes	Elimination methods
The cold-water pipe is filled with hot water	The temperature sensing function of the jet valve has failed	Replace the jet valve
The water from the hot water side of the faucet is not hot	There are branch pipes	Add the number of jet valves needed
	Forgot to open the cold/hot water angle valve at the connection of the jet valve	Open the angle valve
	The non-return function of the jet valve has failed	Replace the jet valve
The pump does not run	The current set time is not turned on	Turn on the current set time
The time returns to zero when the pump is powered on after it is powered off	The built-in button battery of pump is exhausted	Calibrate the time manually

END OF SECTION

WILO USA LLC
262-204-6600
www.wilo-usa.com

Wilo Canada Inc.
403-276-9456
www.wilo-canada.com

Wilo Mexico
+52 442 167 00 32
www.wilo-mexico.com

wilo®