



ND Series

Grade 1 cylindrical locks

Mechanical
Wired electrified
Wireless electronic



The Schlage® ND Series cylindrical locks

Walter Schlage invented the cylindrical lock in 1920. Since then, Schlage Lock Company has consistently delivered innovation and continuous improvement. In that tradition, we are extremely proud to introduce the redesigned ND Series cylindrical lock.

Most manufacturers' approach to locks ends with simply meeting industry standards like Grade 1. With the Schlage ND, Grade 1 is just the beginning.

Performance beyond Grade 1

The Schlage® ND family significantly exceeds BHMA Grade 1 requirements for cycle, lever torque, hammer blow, lever pull and other tests. This means confidence that the lock will last—whether the application calls for high abuse resistance or just operation over millions of cycles—without any degradation in performance.

Comprehensive offering for every opening

Mechanical, wired electrified and wireless electronic solutions allow a common aesthetic and consistent user experience throughout the building while lowering the total cost of ownership.

World-class design

A proven, easy to install product with extensive function, keying, trim and finish capabilities that work in nearly any applications.



Cylindrical lock comparison

ND mechanical



Applications

The Schlage ND is extremely versatile and is regularly used in healthcare, education, government, office, retail and other commercial applications.

With 31 mechanical functions, the ND's range spans from the simple (non-locking passage) to complex (double-cylinder security) to specialized (school time-out lock).

Because the ND uses an ANSI 161 door prep, commonly used across cylindrical locks, it is ideal for both new construction and retrofit applications.

Key features

- Significantly exceeds ANSI/BHMA A156.2 requirements for Grade 1 cylindrical locks
- 31 mechanical functions (see adjacent columns for wired electrified and electronic options)
- Nine lever designs, two rose designs
- 10 available finishes
- Supports standard, SFIC and FSIC cylinder formats
- Multiple key systems available – open, patented, restricted, geographic exclusive, UL437
- Support for 10 non-Schlage cores (see cylinder section)

ND wired electrified



Applications

Wired electrified locks complement the mechanical offering and are typically incorporated into a wired access control system or used independently with a remote access switch (e.g. switch behind a receptionist desk).

The electrified ND is ideally used in:

- high traffic areas, where line power ensures continuous operation
- new construction, where electrified door prep, hinges and wiring can easily be incorporated into the building

Key features

All mechanical features plus:

- auto-detecting 12-24VDC input
- selectable EL/EU operation
- low 0.23 amp max current draw that allows multiple locks on a single power supply
- low 0.010 amp holding current that eliminates “hot levers” in electrically locked applications
- modular Request to Exit (RX) that can be added at any time
- inventory friendly—one lock supports 12-24V, EL or EU, with or without RX
- six electrified functions for application flexibility

NDE wireless electronic



Applications

Wireless electronic locks complete the offering by delivering all of the access control system hardware components required at the door in a single integrated design.

NDE wireless lock applications include:

- retrofit applications where electronic credentials can be used for improved visibility and control
- new construction to expand the scope of access control to interior openings
- low to medium traffic areas, where battery power delivers long life

Key features

All mechanical features¹ plus:

- Fits standard ANSI 161L mechanical door prep
- Installs in minutes with only a Phillips screwdriver
- Integrated card reader, door position sensor and Request to Exit (RX) switch
- Built-in Bluetooth® enables wireless configuration from smart phones and tablets
- Built-in Wi-Fi enables automatic updates to access rights
- Capable of networked real-time communication²
- Up to 2 years of battery life (4 AA)

¹ NDE wireless electronic lock available in seven lever designs, one rose design, and nine finishes only.

² Requires ENGAGE™ Gateway and alliance access control software.

From mechanical to wired electrified to wireless electronic the ND Series offers a grade 1 solution for the entire project.

ND mechanical



Suitable for all openings

ND wired electrified



Ideal for high-traffic access control

NDE wireless electronic



Ideal for low-traffic access control





Selection guide

Key features

Trims and finishes

Mechanical

Wired electrified

Wireless electronic

Keys and credentials

Parts

Specifications

STRONG

The ND Series has been redesigned to make it the strongest cylindrical lock Schlage has ever built.

- No access with minimum 3,100 in-lb abusive lever torque — the equivalent of over 690 lbs applied to the end of a 4 1/2" lever (2.6x BHMA requirements¹)
- No access with minimum 1,600 lbs offset lever pull for protection against pry bar attacks (8x BHMA requirements¹)
- No access with minimum 100 vertical impacts^{1,2} for protection against sledgehammer attacks (20x BHMA requirements¹)
- Near zero droop and wobble after 16M cycles (16x BHMA requirements¹), without the use of set screws or O-rings
- Latch retraction with 200lb preload for confident operation in warped and preloaded doors (4x BHMA requirements)

¹ Beyond grade 1 performance for ND locks with Schlage cylinders only (standard, FSIC & SFIC). Performance with non-Schlage cylinders will exceed BHMA grade 1 requirements but may be less than the performance of products with Schlage cylinders.

² Vertical impact testing stopped after 100 blows with no sign of failure or stress.

SECURE

A strong lock is only part of the security equation—proper key and card access control is equally important.

- Everest 29™ cylinder with S123 keyway is provided standard which prohibits unauthorized key duplication at local stores and is patent protected until 2029
- Available restricted and geographic exclusive keyways for advanced key control
- Available compatibility with 10 different non-Schlage key systems
- SL cylinder option allows SFIC keyway use in a conventional cylinder, providing multiple new keying solutions including geographically exclusive SFIC when paired with Primus XP
- Wired electrified and wireless electronic locks enable the use of electronic credentials for increased visibility and control over access
- Schlage smart credentials with MiFare® DESFire® EV1 technology utilize encryption, mutual authentication and key diversification to ensure the highest levels of security



■ SMART

Smart means using innovation to make your project more efficient, flexible, and easier to install and use.

- One platform, three solutions (mechanical, wired electrified, wireless electronic)—same look and feel throughout the building for a common user experience and lower cost of ownership
- Wired electrified lock has autodetecting 12/24V input, selectable EL/EU operation, and plug-in Request to Exit (RX) for installation and inventory flexibility. Energy efficient design allows multiple locks on a single power supply with no "hot levers"
- Wireless electronic locks with ENGAGE™ can be managed with an access control system or with convenient ENGAGE web and mobile applications.
- Wireless electronic locks provide the option to leverage existing network infrastructure for offline or real-time applications
- Can upgrade from ND mechanical lock to NDE wireless electronic with only a screwdriver



Schlage is more than locks. It's the complete infrastructure of support throughout the entire build and ownership process.

- Order entry, customer service, technical support, engineering and manufacturing co-located in the same building in Colorado Springs, Colorado
- Comprehensive support from our sales offices including consultations, masterkey development and training; industry and code training, specification writing, and product service
- Schlage products suite with other Allegion brands including Von Duprin® exit devices, LCN® door closers, and Steelcraft® doors and frames
- Custom engineering department can develop specialized functions, trim and finishes for unique applications
- Trusted partner for nearly 100 years

A detailed look...

ND mechanical

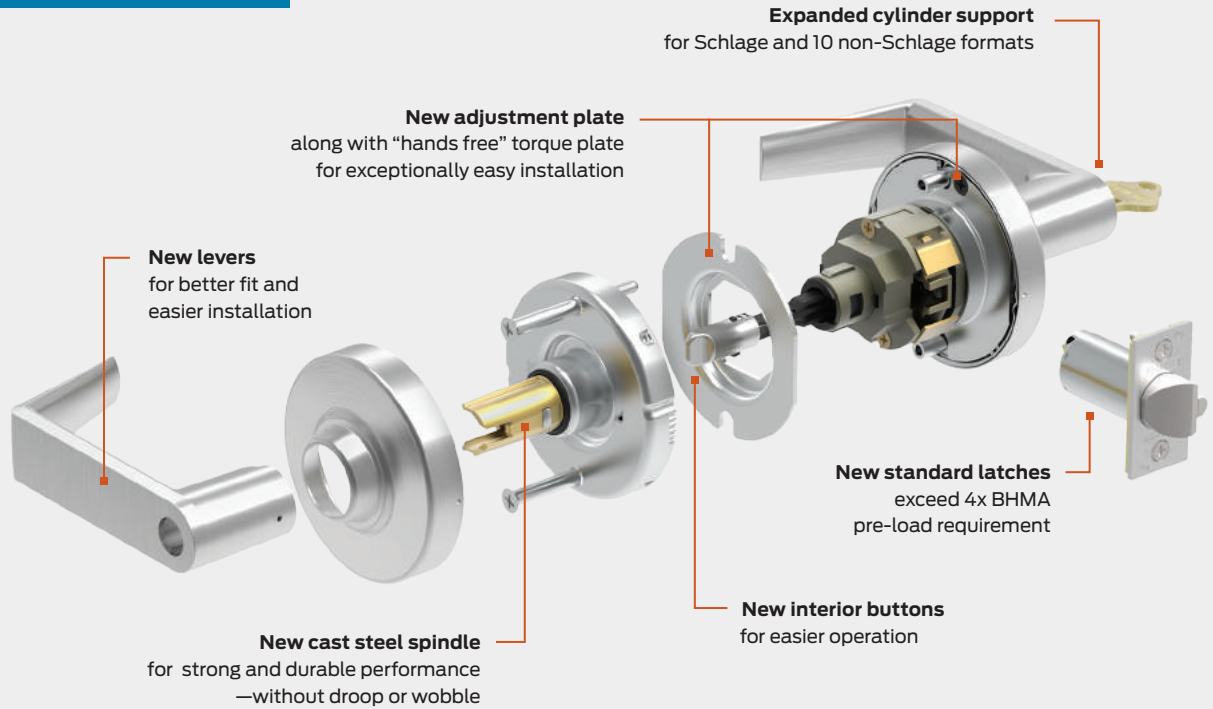

ND wired electrified

All mechanical features +

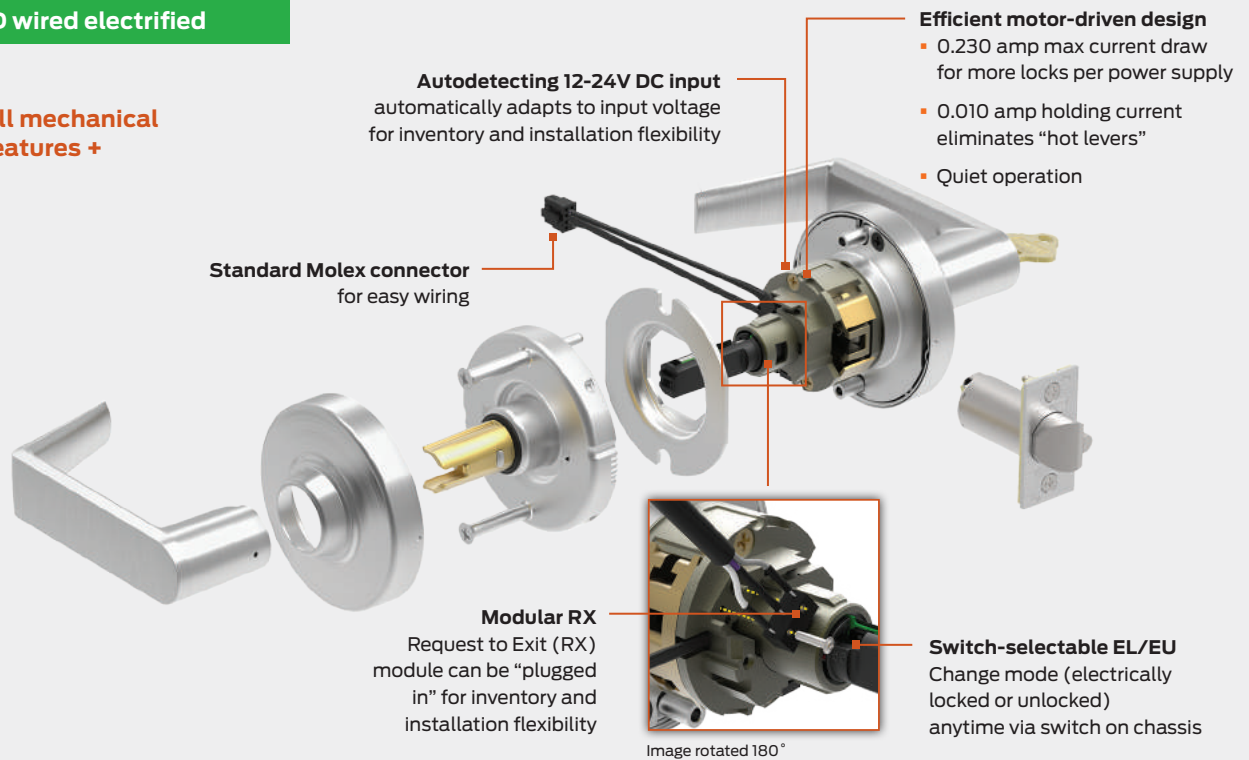

NDE wireless electronic

All mechanical features +

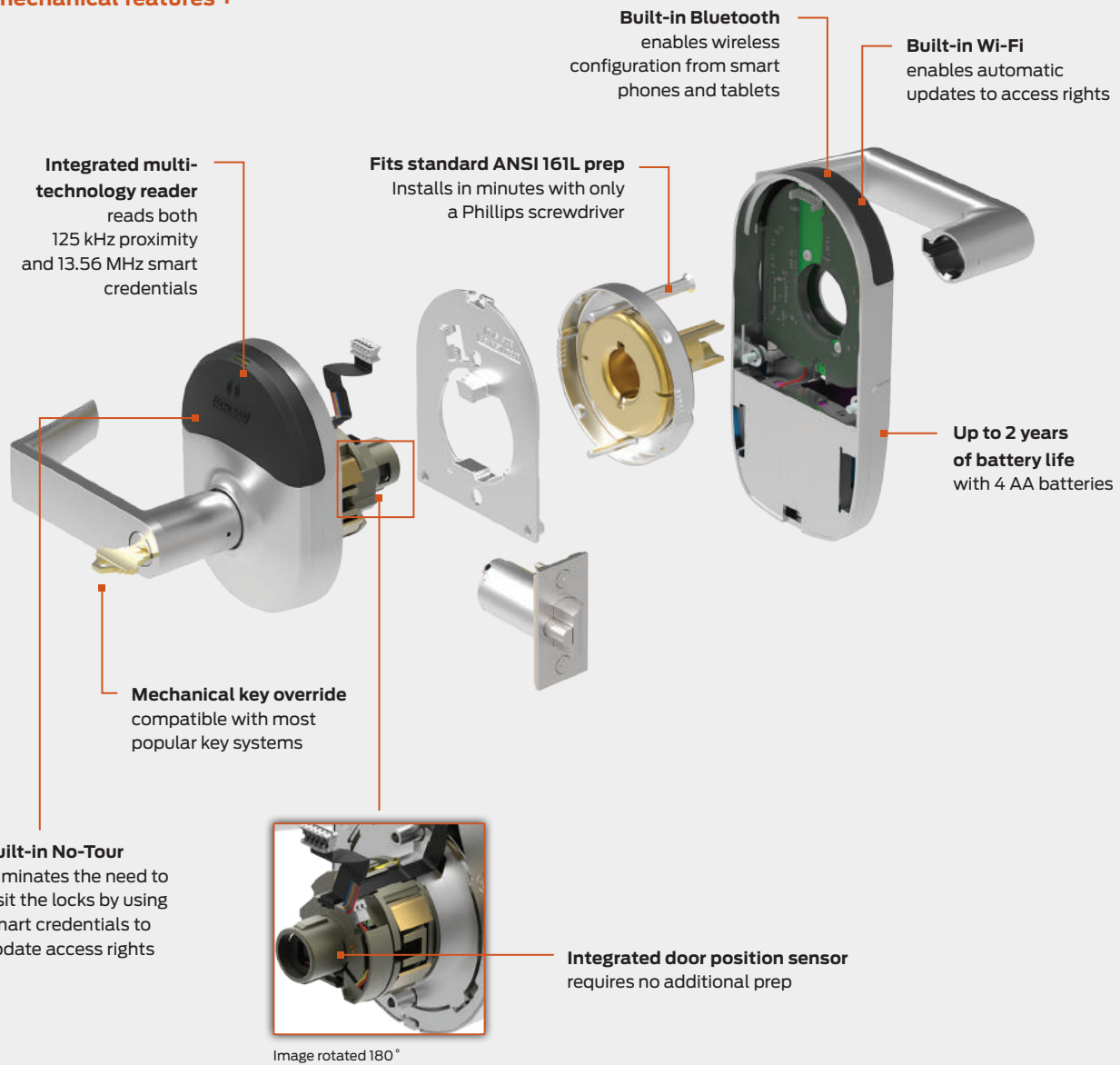

Designs and finishes

Lever designs and finishes

Athens (ATH)²

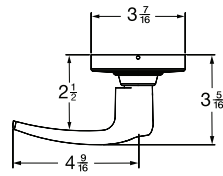

- Mechanical
- Wired electrified
- Wireless electronic

Sparta (SPA)^{1,2}

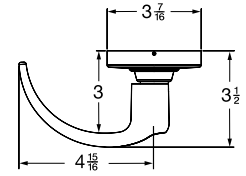

- Mechanical
- Wired electrified
- Wireless electronic

Rhodes (RHO)^{1,2}

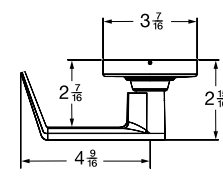

- Mechanical
- Wired electrified
- NDE wireless electronic

Tubular (TLR)^{1,2}

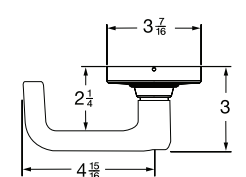

- Mechanical
- Wired electrified
- Wireless electronic

Omega (OME)¹

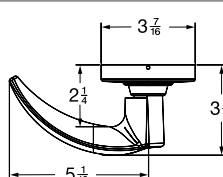

- Mechanical
- Wired electrified
- Wireless electronic

Latitude (LAT)

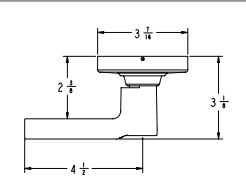

- Mechanical
- Wired electrified
- Wireless electronic

Broadway (BRW)

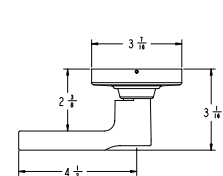

- Mechanical
- Wired electrified
- Wireless electronic

Longitude (LON)

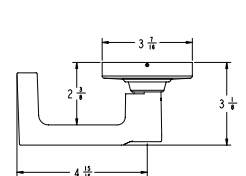

- Mechanical
- Wired electrified
- Wireless electronic

Boardwalk (BWK)

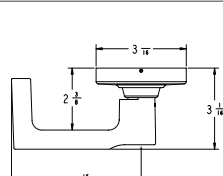

- Mechanical
- Wired electrified
- Wireless electronic

All levers comply with the Americans with Disabilities Act (ADA).

- Boardwalk, Longitude, Omega, Rhodes, Sparta and Tubular levers comply with California State code for return within 1/2" of door face.
- Athens, Rhodes, Sparta and Tubular levers support cylinders from other manufacturers, see cylinder section on page 24 for details.

Finish options									
Color	Bright brass	Satin brass	Satin bronze	Oil rubbed bronze	Satin nickel	Matte black	Bright chrome	Satin chrome	Aged bronze
ANSI/BHMA number	605	606	612	613	619	622	625	626/626AM	643e
US number	US3	US4	US10	US10B	US15	US19	US26	US26D	US11
Mechanical	■	■	■	■	■	■	■	■	■
Wired electrified	■	■	■	■	■	■	■	■	■
Wireless electronic	■	■	■	—	■	■	■	■	■

Product information and specifications contained in this catalog are subject to change without notice. Please consult the factory.

Accessibility and life safety

Accessibility and life safety

Door hardware should be as effective in helping people go about their lives as it is in securing their environments. The Schlage ND is designed with this requirement in mind.

Accessibility

All Schlage ND levers comply with the Americans with Disabilities Act (ADA), which requires that “Operable parts shall be operable with one hand and shall not require tight grasping, pinching, or twisting of the wrist. The force required to activate operable parts shall be 5 pounds (22.2 N) maximum.”



Tactile warning for the visually impaired

Tactile warning is a special texture applied to the outside lever to alert the visually impaired to a potential hazard on the opposite side of the door (exit to street, a workshop or other hazardous area, etc). Tactile warning is typically applied to the outside lever only, and is specified by an 8 prefix on the lever design.

Milled

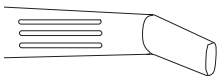

Order as follows:
8AT for Athens
8RO for Rhodes
8SP for Sparta
8LT for Latitude
8LN for Longitude

Knurled

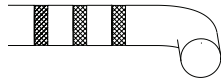

Order as follows:
8TR for Tubular
8BW for Broadway
8BK for Boardwalk

Door handing

The ND lock family can be configured during installation to support any door handing. As a result, it is not necessary to specify handing during the ordering process.

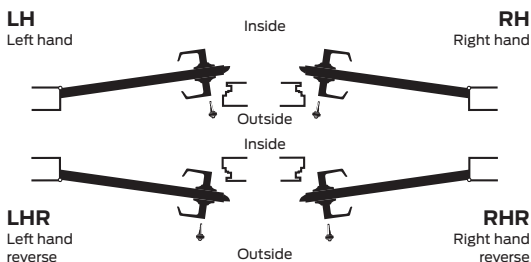

Life safety

The Schlage ND is UL listed for use on 3-hour fire doors up to 4'0" x 10'0". The Boardwalk, Longitude, Omega, Rhodes, Sparta and Tubular levers comply with the California State fire code for return to within 1/2" of the door face.

Additionally, the Schlage ND exceeds the BHMA warped door test by 4x. The BHMA standard requires that the latch be able to retract with a 50lb pre-load; the ND can retract the latch with a 200lb preload - providing more range to open the door in the event the opening becomes bound or otherwise compromised.

Classroom security indicator rose

Schlage ND classroom security functions come standard with an indicator rose that clearly identify key rotation direction for rapid lockdown. For ND mechanical classroom security function only.



ND Series mechanical lock

The ND mechanical lock, along with being Schlage's best selling mechanical lock, is the foundation for both the wired electrified and NDE wireless electronic lock. Not only did Schlage invent the cylindrical lock, but we continue to make it better with capabilities such as:

- Unparalleled strength - the lock prevents access even when subjected to torque loads up to 3,100 in-lbs (2.6x BHMA¹), withstands pry bar attacks of 1,600 lbs (8x BHMA requirements¹), and withstands 100 hammer blows (20x BHMA requirements^{1,2})
- Exceptional durability - cycle tested to over 16M cycles (16x BHMA requirements¹) with near zero droop or wobble - without the use of set screws or O-rings
- Improved feel - improved strength and durability are more than numbers, you can actually feel it in the lock
- Improved installation - installation is even easier than before (and without any set screws or O-rings)

All this is in addition to what you know and expect with the Schlage ND: 31 mechanical functions (plus wired electrified and wireless electronic) to meet the needs of any application; nine lever designs that suite with other Schlage locks and Von Duprin exit devices; renowned sales, customer and technical support.



1 Beyond grade 1 performance for ND locks with Schlage cylinders only (standard, FSIC & SFIC). Performance with non-Schlage cylinders will exceed BHMA grade 1 requirements but may be less than the performance of products with Schlage cylinders.

2 Vertical impact testing stopped after 100 blows with no sign of failure or stress.

ND Series mechanical lock
Keyless function list

Legend

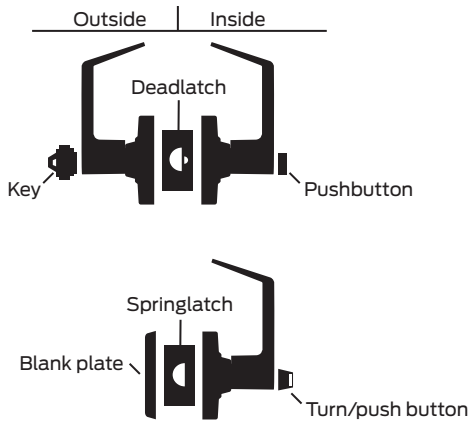

Schlage ANSI

ND10S F75
Passage latch

- Both levers always unlocked.

Schlage ANSI

ND12D F89
Exit lock

- Outside lever always fixed.
- Inside lever always free for immediate egress.

Inside

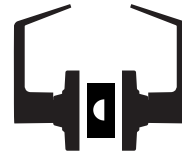

Available with RX

Outside

Inside

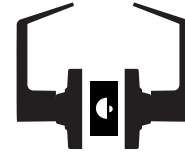

Available with RX

Schlage ANSI

ND25D -
Exit lock

- Blank plate outside.
- Inside lever always free for immediate egress.

Outside

Inside



Schlage ANSI

ND40S F76
Bath/bedroom privacy lock

- Push-button locking.
- Unlocked from outside with a small screwdriver.
- Turn inside lever or close door to release button.
- Inside lever always free for immediate egress.

Outside

Inside



Schlage ANSI

ND44S -
Hospital privacy lock

- Push-button locking.
- Unlocked from outside by turning emergency turn-button.
- Turn inside lever or close door to release button.
- Inside lever always free for immediate egress.

Outside

Inside



Schlage ANSI

ND170 -
Single dummy trim







- Dummy trim for one side of door.
- Used for door pull or as matching inactive trim.

Outside/Inside

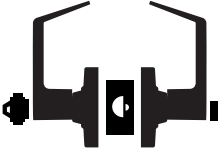
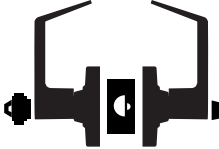
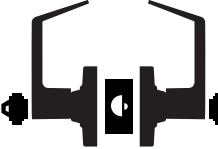

ND Series mechanical lock

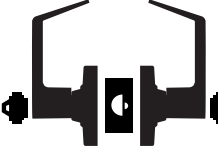
Keyed function list

<p>Schlage ANSI</p> <p>ND50PD F82</p> <p>Entrance/office lock</p> <ul style="list-style-type: none"> • Push-button locking. • Push-button locks outside lever until it is unlocked with key or by turning inside lever. • Inside lever always free for immediate egress. 	<p>Schlage ANSI</p> <p>ND53PD F109</p> <p>Entrance lock</p> <ul style="list-style-type: none"> • Turn/push-button locking: Pushing and turning the button locks the outside lever, requiring use of a key until the button is manually unlocked. • Push-button locking: Pushing button locks outside lever until unlocked by key or by turning the inside lever. • Inside lever always free for immediate egress. 	<p>Schlage ANSI</p> <p>ND60PD F88</p> <p>Vestibule lock</p> <ul style="list-style-type: none"> • Latch retracted by key from outside when outside lever is locked by key in inside lever. • Inside lever always free for immediate egress. 	<p>Schlage ANSI</p> <p>ND66PD F91</p> <p>Store lock†</p> <ul style="list-style-type: none"> • Key in either lever locks or unlocks both levers.
<p>Outside Inside</p> 	<p>Outside Inside</p> 	<p>Outside Inside</p> 	<p>Outside Inside</p> 
<p>Schlage ANSI</p> <p>ND70PD F84</p> <p>Classroom lock</p> <ul style="list-style-type: none"> • Outside lever locked and unlocked by key. • Inside lever always free for immediate egress. 	<p>Schlage ANSI</p> <p>ND73PD F90</p> <p>Corridor lock</p> <ul style="list-style-type: none"> • Locked or unlocked by key from outside. • Push-button locking from inside. • Turn inside lever or close door to release button. • When outside lever is locked by key it can only be unlocked by key. • Inside lever always free for immediate egress. 	<p>Schlage ANSI</p> <p>ND75PD -</p> <p>Classroom security lock</p> <ul style="list-style-type: none"> • Key in either lever locks or unlocks outside lever. • Inside lever always free for immediate egress. 	<p>Schlage ANSI</p> <p>ND80PD F86</p> <p>Storeroom lock</p> <ul style="list-style-type: none"> • Outside lever is fixed. • Entrance by key only. • Inside lever always free for immediate egress.
<p>Outside Inside</p> 	<p>Outside Inside</p> 	<p>Outside Inside</p> 	<p>Outside Inside</p>  <p>Available with RX</p>

ND Series mechanical lock
Keyed function list

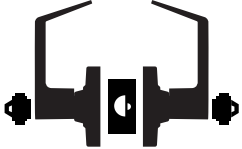
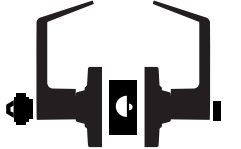
<p>Schlage ANSI</p> <p>ND82PD F87</p> <p>Institution lock†</p> <ul style="list-style-type: none"> • Both levers always fixed. • Entrance by key in either lever. <p>Outside Inside</p> 	<p>Schlage ANSI</p> <p>ND85PD -</p> <p>Faculty restroom lock</p> <ul style="list-style-type: none"> • Outside lever is fixed. • Entrance by key only. • Visual occupancy indicator, allowing only emergency key to operate. • Turn inside lever or close door to unlock. • Rotation of inside spinner-button enables lock-out feature. • Inside lever always free for immediate egress. • Not available with interchangeable core cylinders. <p>Outside Inside</p> 	<p>Electrified locks can be found in the electrified section of the catalog (page 19).</p>
---	--	---

ND Series mechanical lock
Vandlgard™ function list

Vandlgard™ trim is specifically designed for highly abusive environments. The outside lever rotates freely up and down when locked, limiting the ability of vandals to apply excessive force to the chassis

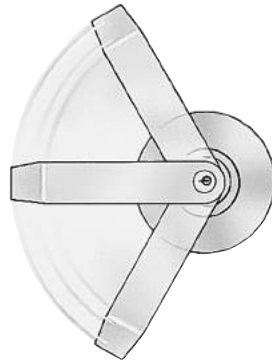

Schlage ANSI

ND91PD F82

Entrance/office lock

- Push-button locking.
- Push-button disengages outside lever until unlocked with key or by turning inside lever.
- Vandlgard allows outside spindle to disengage from latch when locked.
- Inside lever always free for immediate egress.

Outside Inside

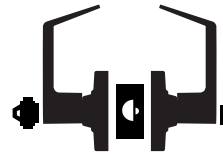

Schlage ANSI

ND92PD F109

Entrance lock

- Turn/push-button locking: Pushing and turning button disengages outside lever, requiring using of key until button is manually unlocked.
- Push-button locking: Pushing button disengages outside lever until unlocked by key or by turning inside lever.
- Vandlgard allows outside spindle to disengage from latch when locked.
- Inside lever always free for immediate egress.

Outside Inside

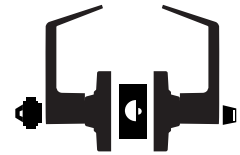

Schlage ANSI

ND93PD F88

Vestibule lock

- Latch retracted by key from outside when outside lever is disengaged by key in inside lever.
- Vandlgard allows outside spindle to disengage from latch when locked.
- Inside lever always free for immediate egress.

Outside Inside

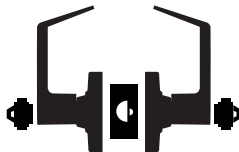

Schlage ANSI

ND94PD F84

Classroom lock

- Outside lever disengaged and unlocked by key.
- Vandlgard allows outside spindle to disengage from latch when locked.
- Inside lever always free for immediate egress.

Outside Inside

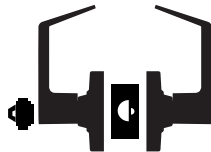

Schlage ANSI

ND95PD -

Classroom security lock

- Key in either lever locks or unlocks outside lever.
- Vandlgard allows outside spindle to disengage from latch when locked.
- Inside lever always free for immediate egress.

Outside Inside



Schlage ANSI

ND96PD F86

Storeroom lock

- Outside lever always disengaged.
- Entrance by key only.
- Vandlgard allows outside spindle to disengage from latch when locked.
- Inside lever always free for immediate egress.

Outside Inside

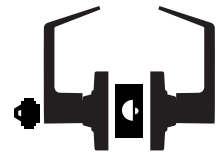

Available with RX

ND Series mechanical lock Vandlgard and special function list

Schlage ANSI

ND97PD F90

Corridor lock

- Locked or unlocked by key from outside.
- Push-button locking from inside.
- Turning inside lever or closing door releases button.
- When outside lever is locked by key it can only be unlocked by key.
- Vandlgard allows outside spindle to disengage from latch when locked.
- Inside lever always free for immediate egress.

Outside Inside

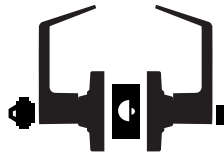

Schlage ANSI

ND45 -

Time out lock

- Pushing and holding outside button disengages inside spindle, allowing inside lever to free-wheel without retracting latch. Release of outside button allows free egress from inside.

Outside Inside



ND Series other special functions

ND30D

Patio lock

Push button locking. Turning inside lever or closing door releases button, preventing a lock-out. Inside lever always free for immediate egress. Specify per XN12-007.

ND25 x 80PD

Storeroom exit lock

Blank plate outside. Key in fixed inside lever retracts latch. Specify per XN12-005.

ND25 x 70PD

Classroom exit lock

Blank plate outside. Key locks or unlocks inside lever. Specify per XN12-004.

ND60PD

Vestibule with closed outside lever

Same as ND60 except outside lever is closed. Inside lever always free for immediate egress. Specify per XN12-001.

ND70 x 80PD

Classroom by storeroom lock

Key locks and unlocks outside lever. Key in fixed inside lever retracts latch. Specify per XN12-006.

ND72PD

Communicating lock

Key in either lever locks and unlocks respective lever. Specify per XN12-002.

ND72PD

Vandlgard communicating lock

Communicating, ND72, lock with Vandlgard. Key in either lever locks and unlocks own lever. Both inside and outside levers are clutching. Specify per XN12-003.

Electrified locks can be found in the electrified section of the brochure (page 18).

ND Series wired electrified locks

The ND wired electrified lock complements the ND mechanical lock by working with access control systems to provide advanced security in high traffic areas. Because the electrified ND uses a motor instead of a solenoid, it offers unparalleled energy efficiency and flexibility in wired electrified applications.

More ECO. A maximum current draw of 0.23 amps not only saves energy, but by allowing more locks to run off a single power supply it saves money as well. The low 0.010 amp holding current eliminates any potential for hot levers in electrically locking applications or in electrically unlocking applications where the door is left open for long periods of time.

More FLEX. The electrified ND has flexibility for any application—it automatically operates from 12 to 24VDC, and the operating mode (electrically locked or unlocked) can be changed by simply toggling a switch on the chassis. Request to Exit (RX) can even be added with a simple upgrade kit.

The electrified ND has a number of other features and benefits. Incredibly quiet operation. Tested to over 4x BHMA standards. The electrified ND also comes standard with the Allegion connect Molex™ connector system (may be cut off and installed using traditional splicing methods if desired).



ND Series wired electrified lock
Function list

Keyless		Keyed		Keyed Vandlgard	
Schlage	ANSI	Schlage	ANSI	Schlage	ANSI
ND12ELD ND12EUD	-	ND80ELPD ND80EUPD	-	ND96ELPD ND96EUPD	-
Keyless electrified exit		Electrified storeroom		Electrified storeroom with Vandlgard	
<ul style="list-style-type: none"> • Outside lever continuously locked (EL) or unlocked (EU) by 12-24V DC. • EL is fail safe (power fail unlocks outside lever). • EU is fail secure (power fail locks outside lever). • Inside lever always free for immediate egress. 		<ul style="list-style-type: none"> • Outside lever continuously locked (EL) or unlocked (EU) by 12-24V DC. • EL is fail safe (power fail unlocks outside lever). • EU is fail secure (power fail locks outside lever). • Key outside serves as mechanical override. • Inside lever always free for immediate egress. 		<ul style="list-style-type: none"> • Adds Vandlgard to ND80EL/EU. • Vandlgard allows outside spindle to disengage from latch when locked, limiting the ability of vandals to apply excessive force to the chassis. See page 16 for more details. 	
Outside	Inside	Outside	Inside	Outside	Inside
Electrified Available with RX		Electrified Available with RX		Electrified Available with RX	

Electrical requirements

- Input voltage: auto-detects 10.8-26.8VDC
- Max current draw: 0.230 amp (230mA)
- Holding current: 0.010 amp (10mA)
- Temperature range: 32°F-120°F (0°-49°C)

Request to Exit (RX)

- Normally open, normally closed and common leads provided
- Electrical rating: 2A, 30VDC max
- Order (with lock): specify RX in option field
- Order (retrofit): p/n N123-062

Wiring instructions

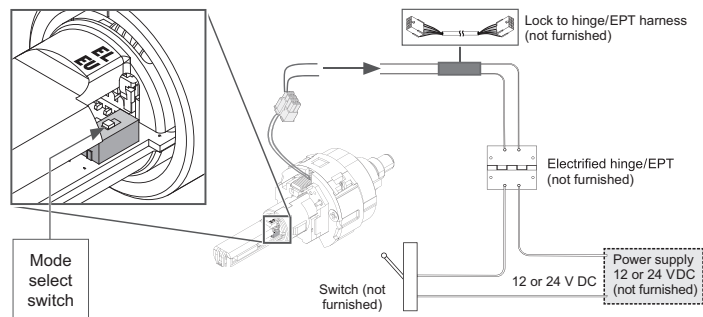

Maximum Total Wire Length				
AWG	14	16	18	20
12 V	500' (152 m)	300' (91 m)	200' (61 m)	100' (30 m)
24 V	Up to 1000' (304 m)			

Note: Either lock wire may be attached to either power supply terminal (+ or -).

NDE wireless electronic locks

NDE wireless locks simplify installation by combining the lock, credential reader, door position sensor and Request to Exit (RX) into a single integrated design. NDE shares the same standard cylindrical door prep as the ND lock and installs in minutes with only a Philips screwdriver.

Built-in Bluetooth® enables NDE wireless locks to connect directly to smart phones and tablets—no need for a proprietary handheld device for set-up and configuration.

Built-in Wi-Fi enables NDE to connect directly to an existing Wi-Fi network for automatic updates to access rights and configuration.

With the ENGAGE cloud-based web and mobile apps, it's easy to configure lock settings, manage access rights, and view audits and alerts from anywhere. Updates can be sent any time at the lock with the ENGAGE mobile app and occur automatically overnight when NDE is configured to connect to a Wi-Fi network.

NDE wireless locks can also be connected to the ENGAGE Gateway for real-time networked communication with software from one of our software alliance members.



NDE wireless electronic locks

Function

Schlage **ANSI**
NDE80PD **F86**
Lock with Vandlgard

- Can be used for perimeter doors, suite entrances, offices, and sensitive storage spaces.
- Lockset is normally secure with outside lever disengaged.
- Valid credential or key momentarily unlocks door.
- Valid credential may be used to change to a passage or secured state.
- Lock schedule may be implemented to put the lock in a passage or secured state.
- Inside lever always allows free egress.

Included status monitors

- Request to Exit
- Door position
- Interior cover tamper⁵
- Magnetic tamper
- Battery status
- Lock/unlock status⁶
- Communication status⁵

Product specifications

Wireless lock specifications	
Users	Up to 5,000 ¹
Audits	Up to 2,000 ²
Credential verification time	≤ 1 second ³
Visual communications	LED (red, amber, green)
Audible communications	Audible indicator (field configurable)
Gateway communication range	Up to 30' in typical building environments. A detailed site survey is recommended. Reference ENGAGE™ Gateway Data Sheet for additional detail.
Wake-Up on Radio	Responds to command from host in less than 5 seconds when linked to ENGAGE Gateway (requires alliance partner software)
Battery life	Up to 2 yrs with 4 AA batteries ⁴
Operating temperature (exterior)	-31° to 151°F (-35° to 66°C)
Operating temperature (interior)	32° to 120°F (0° to 49°C) (battery)
Operating humidity	0 - 100% non-condensing
Certifications	ANSI/BHMA A156.25-2013 (Indoor/Outdoor), ANSI/BHMA A156.2-2011, Series 4000, Grade 1, UL 294, UL 10C, CSA C22.2 No. 205-M1983, FCC Part 15, IC RSS-210, ADA, RoHS, ICC ANSI A117.1

Multi-technology reader specifications	
Frequency	125 kHz proximity and 13.56 MHz smart credential
Standards	ISO standard 15693 and ISO 14443
Maximum read range	Up to 1.25" on 125 kHz proximity, up to 0.75" on 13.56 MHz smart credential

¹ Maximum database storage capacity of lock. Can vary upon access control software database capacity when paired with an ENGAGE Gateway RS-485 to ACP
² Maximum audit storage capacity of lock. Can vary upon access control software audit storage capacity when paired with an ENGAGE Gateway RS-485 to ACP
³ Response time does not include latency time of host when linked to an ENGAGE Gateway
⁴ Assuming indoor application, 13.56 MHz CSN credential, 100 actuations and one Wi-Fi update per day
⁵ Consult your access control software provider for specific scope of support
⁶ Software indicates lock/unlock status based on sequence of events

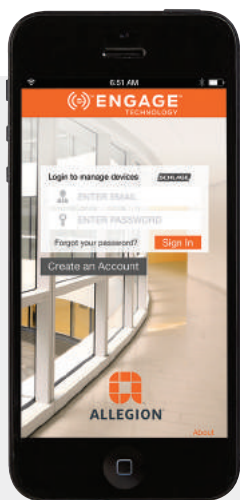

ENGAGE cloud-based web and mobile applications

ENGAGE cloud-based web and mobile apps make it easy to configure lock settings, manage access rights and view audits and alerts from anywhere.



Cylinders and key systems

A strong lock is only part of the security solution—proper key control is equally important. Schlage offers extensive options to meet the security needs of the specific project.

Cylinders

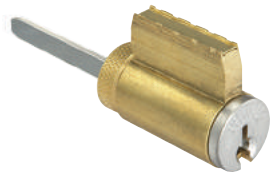

Conventional KIL cylinder options¹

- 6-pin length (standard)
- 7-pin length in SL cylinder
- Available in Schlage Classic and Everest 29™ open and restricted keyways
- Primus® XP security features and geographic exclusivity
- Primus XP UL 437 listed high security features
- Hotel cylinder (for use in faculty restroom function)

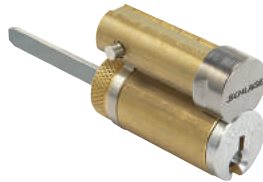

Full size interchangeable core (FSIC) options¹

- 6-pin length
- Available in Schlage Classic and Everest 29 open and restricted keyways
- Interchangeable core compatible with conventional cylinder key systems
- Primus XP security features and geographic exclusivity



Small format interchangeable core (SFIC) options²

- 7-pin combined Everest 29 R restricted keyways³
- 6 or 7-pin uncombined Falcon®/Best® keyways⁴

¹ Available in 606, 622, 626 and 643 plug face finishes; Everest 29 S123 keyway standard.

² Available 606, 613 (simulated), 622, 626 and 643e finish only.

³ Restricted keyway cores require authorization from the end user.

⁴ Must be ordered separately from lock; not available factory keyed.

Key systems

Classic keyway

- Open keyway—keys are duplicated and available without ordering formalities
- Upgradeable to Primus XP and UL 437 levels of security

Everest 29

- Patented through 2029
- Key duplication is restricted providing a higher level of security for the cylinder
- Can be integrated to an existing Everest B, C, or D system
- Upgradeable to Primus XP and UL 437 levels of security

Primus XP

- Independent, dual locking mechanisms
- Unique side bit milling on key makes unauthorized duplication highly enforceable
- Allows creation of geographically exclusive keys in a thousand available combinations
- Provides patent protection when applied to Schlage Classic keyways
- Compatible to all Everest and Everest 29 keyways

Everest 29 SL

- A high security conventional (KIL) cylinder pinned on an A2 system compatible with the Schlage Everest B and Everest 29 R keyways
- Users can expand existing Everest B and Everest 29 R key systems
- Enables Primus XP and UL 437 upgrades on SFIC keyways

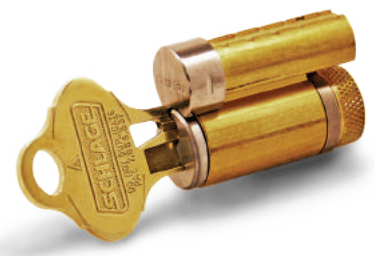

Readers and credentials

Schlage's comprehensive portfolio of electronic credentials and wall mount readers are designed to provide enhanced levels of security, efficiency and convenience to any facility.

Proximity (125 kHz) technology:

- Basic open contactless technology; recommended for legacy systems only
- Encoded with a unique number that cannot be updated or changed

Smart (13.56 MHz) technology:

- Advanced contactless technology, more secure than magnetic stripe and proximity options
- Advanced data encryption secures against duplication
- Recommended for new systems
- Open platform, designed to work with a wide array of systems and applications beyond access control

Multi-technology options that provide flexibility:

- All multi-technology credentials and readers feature aptiQ technology with either magnetic stripe or proximity
- Enables migration from legacy platform to secure smart technology
- Reader options available with keypad for +PIN for high security applications



Credentials

Options include clamshell or ISO cards, keyfobs, wristbands and mobile.

Readers

Single-technology proximity (PR) and smart (SM) readers available in a mini mullion design. Multi-technology (MT) options include mullion, single gang and single gang with keypad (K).

Power supplies



Schlage power supplies are designed for speed and ease of installation upfront with the assurance post installation of the highest quality output in terms of even power flow to protect downstream devices.

Lock options

Latches

ND latches are adjustable for flat or beveled edge doors, and are finished to match the lock trim. All ND Series latches have 1/2" throw and 1" housings except the anti-friction fire door latch, which has a 3/4" throw. Please see the Schlage pricebook for more options including extended backset strikes (up to 5") and rabbited latch and strike kits.

	Part number	Backset	Description
Springlatch	13-248	2 3/4"	Square corner, 1 1/8" x 2 1/4" (default springlatch)
	14-010	3 3/4"	Square corner, 1 1/8" x 2 1/4"
Deadlatch	14-047	2 3/8"	Square corner, 1 1/8" x 2 1/4"
	14-048	2 3/8"	Square corner, 1" x 2 1/4"
	13-247	2 3/4"	Square corner, 1 1/8" x 2 1/4" (default deadlatch)
	14-042	2 3/4"	Anti-friction fire door latch (3/4" throw)
	14-028	3 3/4"	Square corner, 1 1/8" x 2 1/4"

Springlatch

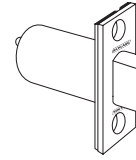

Deadlatch

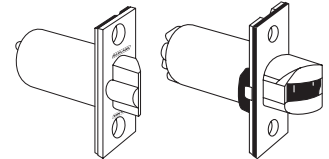

3/4" throw anti-friction deadlatch for pairs of fire doors

Strikes

The ND Series is available with both T-Strike and ANSI strikes in a variety of lip lengths to accommodate different door preps.

	Part number	Description
T-strike	10-013 xx	T-strike, square corner, with strike box, 1 1/8" x 2 3/4". Specify lip length (xx) as 1 1/8" or 1 1/2". For ND and wired ND only.
	10-016	T-strike, square corner, with deep strike box, for fire door latch. 1 1/8" x 2 3/4" w/ 1 1/8" lip. For ND and wired ND only.
	10-132 xx	T-strike, square corner, with strike box, DPS magnet, 1 1/8" x 2 3/4". Specify lip length (xx) as 1 1/8" or 1 1/2". For NDE only.
	10-133 xx	T-strike, square corner, with deep strike box, DPS magnet, for fire door latch. 1 1/8" x 2 3/4" w/ 1 1/8" lip. For NDE only.
ANSI	10-025 xx	ANSI, no box, 1 1/4" x 4 7/8". Specify lip length (xx) as 1 3/16", 1 3/8" or 1 1/2" (1 3/16" lip is default strike). For ND and wired ND only.
	K510-066	Box for ANSI strike.
	10-130 xx	ANSI, no box, DPS magnets, 1 1/4" x 4 7/8". Specify lip length (xx) as 1 3/16", 1 3/8" or 1 1/2" (1 3/16" lip is default strike). For NDE only.

T-strike

(10-013)
1 1/8" x 2 3/4" x 3/32"



ANSI strike - standard

(10-025)
1 1/4" x 4 7/8" x 3/32"

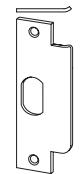

Non-Schlage cylinders

The ND lock can accommodate cylinders from a variety of manufacturers, provided it is specified when ordering the lock.

Cylinder type	Cylinder code	Cylinder type	Cylinder code
Sargent KIL ¹	L-SAR	Yale FSIC ¹	J-YA6
Sargent FSIC ¹	J-SAR	Yale FSIC 7-pin ²	J-YA7
CR KIL ¹	L-CO6	Medeco 31 ¹	J-YA6
CR FSIC ¹	J-CO6	Medeco 32 ¹	J-MED
CR FSIC 7-pin ²	J-CO7	Best	see SFIC cylinder instructions page 25

¹ Available in ATH, RHO, SPA, TLR lever designs only.

² CR and Yale FSIC 7-pin available RHO only.

Ordering instructions

Example

	Function + cylinder	Outside		Inside		Door				
		Lever	Finish	Lever	Finish	Latch	Strike	Thickness	Extension	Dimension
Mechanical	ND53PD	ATH	626							
Wired electrified	ND80EUL	RHO	605	SPA	619	14-048	10-013	214	EE	118
Wireless electronic	NDE80BD	SPA	619							

Detail

Function	Mechanical: See pages 12-17 Wired electrified: See pages 18-19 Wireless electronic: NDE80; see pages 20-21
Cylinder	Standard: P (Patented Everest 29) L (less cylinder) C (less double cylinder) Z (Everest SL) Full size Interchangeable (FSIC): R (FSIC, Patented Everest29) J (FSIC, less core) T (FSIC, Construction Core) Small format Interchangeable: GD (SFIC, Patented Everest 29) BD (SFIC, less core) BDC (SFIC, disposable core) HD (SFIC, construction core)
	For non-Schlage cylinders please see page 24
Outside lever	ATH (Athens), RHO (Rhodes), SPA (Sparta), TLR (Tubular), OME (Omega), LAT (Latitude), LON (Longitude), BRW (Broadway), BRK (Boardwalk) Note: Specify tactile as: 8AT (Athens), 8RO (Rhodes), 8SP (Sparta), 8TR (Tubular), 8LT (Latitude), 8LN (Longitude), 8BY (Broadway), 8BK (Boardwalk)
Outside finish	605 Bright brass (US3) 606 Satin brass (US4) 612 Satin bronze (US10) 613 Oil rubbed bronze (US10B) ¹ 619 Satin nickel (US15) 622 Matte black (US19) 626 Satin chrome (US26D) 626AM Satin chrome anti-microbial 625 Bright chrome (US26) 643e Aged bronze (US11)
	¹ Not available NDE wireless electronic
Inside lever	Specify only if different from outside lever. Same options as outside lever.
Inside finish	Specify only if different from outside finish. Same options as outside finish.
Latch	Specify only if different from standard latch; see page 24 for options.
Strike	Specify only if different from standard strike; see page 24 for options.
Door thickness	Specify only if outside standard door range (1 ⁵ / ₈ "-2 ¹ / ₈ "). Extended door thickness not available NDE wireless electronic.
Extension	Specify only for doors 2 ¹ / ₈ " or greater. Example: EE = Extended Equally, EI = Extended Inside, EO = Extended Outside, ED = Extended Differently
Dimension	Specify only for non-standard strike lip length.
Options	Specify any additional requirements or options. Example: KA = Keyed Alike, KD = Keyed Different, Obit, etc.

Product specifications

		ND mechanical and ND wired electrified	NDE wireless electronic
Chassis	Material	Modular design of zinc and steel components plated for corrosion protection	
	Door thickness	Standard: 1 5/8" to 2 1/8" Optional: 1 3/8" - 6" EE, EO, EI, ED configurations	Standard - 1 5/8" to 2"
Trim	Handing	Non-Handed	Default to Right Hand, configurable without tools
	Levers	Standard: Nine designs, pressure cast zinc, plated to match product finish specification Optional: Tactile feature - Athens (ATH), Rhodes (RHO), Sparta (SPA), Tubular (TLR), LAT (Latitude), LON (Longitude), BRW (Broadway), BRK (Boardwalk)	
	Roses	Wrought brass, bronze, or zinc, plated to match product finish specification	Zinc, plated to match product finish specification
	Finishes	10 available (605, 606, 612, 613, 619, 622, 625, 626, 626AM, 643e)	9 available (605, 606, 612, 619, 622, 625, 626, 626AM, 643e)
Latches	Backset	Standard: 2 3/4" Optional: 2 3/8", 3 3/4", 7 3/4"	Standard: 2 3/4" Optional: 2 3/8"
	Faceplate	Standard : 1 1/8" x 2 1/4" Optional: 1" x 2 1/4" for 2 3/8" backset doors	Standard: 1 1/8" x 2 1/4"
	Bolt	Standard : 1/2" throw via Oil Impregnated Stainless Steel Optional : 3/4" throw anti-friction bolt available for pairs of doors	
	Strike	Standard: ANSI Curved Lip: 1 1/4" x 4 7/8" x 1 3/16" Optional: T Strike, ANSI strikes with alternative lip lengths, dust box options	
Keying	Formats	Standard: 3 Schlage (KIL or FSIC or SFIC) Optional: 10 Non-Schlage including cylinders from Best, Corbin Russwin, Medeco, Sargent and Yale	
	Access security	Standard : 6-Pin Patented Everest 29 Optional: Open, Restricted, Primus, master keying, construction keying	
Wired electrified	Input voltage	Autodetecting 12-24V DC, + 10%	—
	Operating mode	Fail Safe or Fail Secure via switch on chassis	—
	Current draw	0.23 amps maximum; 0.01 amps holding	—
	Request to Exit	Modular - 3A @ 125VAC / 2A @ 30VDC	—
Wireless electronic	Input voltage	—	4 AA batteries
	Operating mode	—	Selectable - secured, as-is, or passage
	Communication	—	2.4 GHz Wi-Fi (IEEE 802.11b/g) Bluetooth low energy (version 4.0)
	Request to Exit	—	Integrated into chassis
	Door position sensor	—	Integrated magnetometer with strike and magnet assembly. Includes magnetic tamper alert.
	Tamper sensor	—	Integrated interior cover tamper
Warranty	Mechanical	10 years mechanical, 1 year wired electrified	1 year wireless electronic
Certifications	ANSI/BHMA	All ND Series comply with A156.2 performance requirements for grade 1 cylindrical locks. Wired electrified complies with A156.25 (indoor), wireless electronic complies with A156.25 (indoor/outdoor) requirements for electrified locking devices	
	ICC	Complies with ICC A117.1 Accessible and Usable Buildings and Facilities	
	UL/cUL	All locks 3 hour A label single fire door 4'0" x 10'0"; pair doors 3 hour fire door 8'0" x 8'0" with 3/4" latch option; pair doors 90 minute fire 8'0" x 10'0" with 3/4" latch option	
	CA Fire Code	All levers with a return to door of 1/2" (64 mm) or less comply (Rhodes, Sparta, Tubular, Omega, Longitude and Boardwalk)	
	FL Building Code	Complies with Florida Building Code (ASTM E330, E1886, E1996) and Miami Dade (TAS 201, 202, 203) requirements for hurricanes	
	Federal	Meets FF-H-106C Series 161	—
	Other	—	UL294, CSA C22.2 No. 205-M1983, FCC Part 15, IC RSS-210, RoHS

Architectural architectural specifications

General specifications - applies to mechanical, wired electrified & NDE wireless electronic

1. Provide Schlage ND Series cylindrical locks conforming to the following standards and requirements:
 - a. ANSI/BHMA A156.2 Series 4000, Grade 1
 - b. UL10C for 4'0" x 10'0" 3-hour fire door
 - c. Florida Building Code (ASTM E330, E1886, E1996) and Miami Dade (TAS 201, 202, 203) requirements for hurricanes
 2. Provide cylindrical locks **exceeding** the ANSI/BHMA A156.2 Grade 1 performance standards for strength, security and durability in the categories below:
 - a. **Abusive locked lever torque** – minimum 3,100 inch-pounds without gaining access
 - b. **Offset lever pull** – minimum 1,600 foot pounds without gaining access
 - c. **Vertical lever impact** – minimum 100 impacts without gaining access
 - d. **Cycle life** – minimum 16 million cycles
 - 1) With no visible lever sag
 - 2) Without the use of performance aids (i.e. – set screws, spacers, etc.)
 3. Provide locksets with **solid cast levers** and **wrought roses** on both sides. (**ND mechanical, ND wired electrified**)
 - a. Lever design: Rhodes, Athens, Sparta, Tubular, Omega, Latitude, Longitude, Boardwalk or Boardwalk
 - b. Rose design: Rhodes (used with Rhodes, Athens, Sparta, Tubular, Latitude, Longitude, Boardwalk or Boardwalk levers) or Omega (used with Omega lever)
 - c. **OPTION (where required by Authority Having Jurisdiction)**- Provide tactile warning on levers on exterior (secure side) of doors serving rooms or areas considered to be hazardous.
 - d. **OPTION** - Provide break away Rhodes levers for an additional level of security
 4. Provide locksets with **solid cast levers** and **cast escutcheons** on both sides (**NDE wireless electrified**)
 - a. Lever design: Rhodes, Athens, Sparta, Latitude, Longitude, Boardwalk or Boardwalk
 - b. **OPTION (where required by Authority Having Jurisdiction)**- Provide tactile warning on levers on exterior (secure side) of doors serving rooms or areas considered to be hazardous.
 - c. **OPTION** - Provide break away Rhodes levers for an additional level of security
 5. Provide locksets with **solid steel anti-rotation** through bolts and posts to control excessive lever rotation
 6. Provide **independently operating levers** with two external return spring cassettes mounted under roses to prevent lever sag.
 7. **OPTION/Standard NDE wireless electrified** – Provide Vandgard/Free-Wheeling levers with vandal resistant technology for use at heavy traffic or abusive applications.
 8. **OPTION** - Provide cylindrical locks with an inside indicator feature on a 626 finish for the Rhodes and Omega roses that provides clear direction for users to safely and quickly secure the room
 - a. **ND75 and ND95 – Standard**
 - b. **ND60 and ND93 – OPTION**
 9. Provide locks with **standard latches** featuring a 2 3/4" (70 mm) backset and a 1/2" latch throw capable of UL listing of 3 hours on a 4.0 x 10.0 opening. Provide proper latch throw for UL listing at pairs.
 10. Provide standard **ASA strikes** unless extended lip strikes are required to protect trim.
 11. **OPTION ND mechanical** – Provide reconfigurable lockset chassis that allows lock function to be changed to over twenty other common functions by swapping easily accessible parts
- Add for ND wired electrified**
12. Provide wired electrified options as scheduled in the hardware sets.
 - a. 12 through 24V DC operating capability, autodetecting
 - b. Selectable EL (Fail Safe)/EU (Fail Secure) operating mode via switch on chassis
 - c. 0.230A (230mA) maximum current draw
 - d. 0.010A (10mA) holding current
 - e. Modular / "plug in" Request to Exit switch
- Add for NDE wireless electronic**
12. Provide lockset with additional standard compliance:
 - a. Listed, UL 294 - standard of Safety for Access Control System Units
 - b. Compliant with ANSI/BHMA A156.25 Grade 1 Operation and Security
 - c. Certified to FCC Part 15
 13. Provide credential reader module in the following configuration, as indicated in the door hardware sets. Multi-technology contactless reader shall be NFC-Compatible, including NFC Peer to Peer compatibility, and read access control data from both 125 kHz and 13.56MHz contactless smart cards.
 14. Provide lockset with the following switches/monitors standard:
 - a. Door Position Sensor (DPS)
 - b. Interior cover tamper guard
 - c. Request to Exit (RX) switch
 15. Provide locksets with the following features
 - a. Ability to communicate unit's communication status
 - b. Visual tri-colored LED indicator that indicates activation, operational systems status, system error conditions and low power conditions
 - c. Audible feedback that can be enabled or disabled
 - d. Tamper resistant torx screw on inside escutcheon
 16. Provide lockset with open architecture characteristics capable of handling new and existing access control software and credential reading technology
 17. Provide lockset powered by four AA batteries
 - a. Provide locksets able to communicate battery status and battery voltage level by means of application on mobile device at the door or remotely via integrated software
- 1 Beyond grade 1 performance for ND locks with Schlage cylinders only (standard, FSIC and SFIC). Performance with non-Schlage cylinders will exceed BHMA Grade 1 requirements but may be less than the performance of products with Schlage cylinders.

About Allegion

Allegion (NYSE: ALLE) is a global pioneer in safety and security, with leading brands like CISA®, Interflex®, LCN®, Schlage®, SimonsVoss® and Von Duprin®. Focusing on security around the door and adjacent areas, Allegion produces a range of solutions for homes, businesses, schools and other institutions. Allegion is a \$2 billion company, with products sold in almost 130 countries.

For more, visit www.allegion.com

KRYPTONITE ■ LCN ■  ■ STEELCRAFT ■ VON DUPRIN