

# Powerpole® Connectors

## - PP75: up to 120 Amps

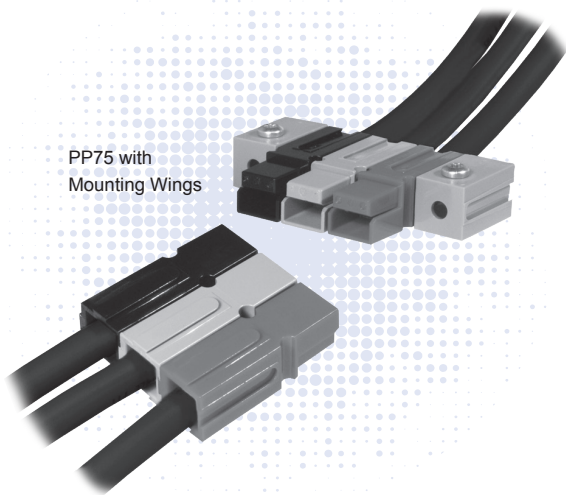

PP75 series Powerpole® housings can be used for wire-to-wire, wire-to-board, and wire-to-busbar applications. Wire sizes from #16 AWG (1.3 mm<sup>2</sup>) to #6 (13.3 mm<sup>2</sup>) offer power capabilities up to 120 amps per pole. Locking housings offer the capability to secure Powerpole® housings to each other and to mounting pads. Housings made from chemical resistant (CR) resin withstand industrial solvents better than standard housings.

- **Large Wire Range Accommodates up to #6 (10mm<sup>2</sup>) Wire**  
*Reducing bushings allow as small as #16 (1.5 mm<sup>2</sup>) wire to be used*
- **Wire, PCB, and Busbar Contacts**  
*Allows one connection system to meet multiple needs*
- **Mini-Powerclaw PCB Contacts Minimize PCB Footprint**  
*Removes the PP75 housing from the board side*

### | PP75 ORDERING INFORMATION |

#### PP75 Standard Housings

The second smallest Powerpole® housing can be used with wire contacts up to 6 AWG [10mm<sup>2</sup>] as well as PCB and busbar contacts.

Description	----- Part Numbers -----	
Minimum Quantity ...	1,000	100 .....
Red	5916G7-BK	5916G7
Green	5916G6-BK	5916G6
Black	5916G4-BK	5916G4
White	5916G5-BK	5916G5
Blue	5916-BK	5916
Yellow	5916G15-BK	5916G15
Orange	5916G14-BK	5916G14
Gray	5916G16-BK	5916G16

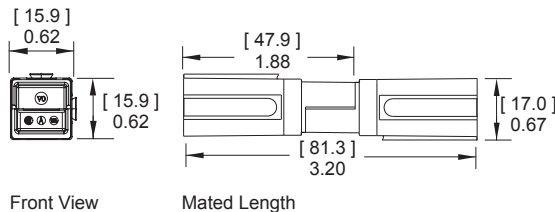

#### PP75 Chemical Resistant (CR) Housings

Has the same form and dimensions of the standard PP75 housing in a chemical resistant PBT/ PC blend housing. Suitable for use to -40°C.

Description	- Part Numbers -	
Minimum Quantity ...	1,000	.....
Red	P5916G7-BK	
Black	P5916G4-BK	
White	P5916G5-BK	
Blue	P5916-BK	

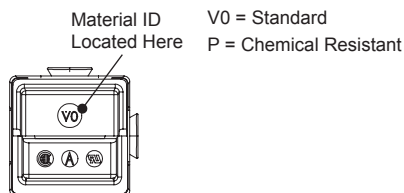

#### PP75 Locking Dovetail Housings

Offers dovetails for stacking housings that have a locking feature to prevent housings separating. Can mate to standard and chemical resistant housings, but cannot be stacked with them.

Description	----- Part Numbers -----	
Minimum Quantity ....	1,000	100 .....
Red	75LOKRED-BK	75LOKRED
Green	75LOKGRN-BK	75LOKGRN
Black	75LOKBLK-BK	75LOKBLK
White	75LOKWHT-BK	75LOKWHT
Blue	75LOKBLU-BK	75LOKBLU
Gray	75LOKGRA-BK	75LOKGRA

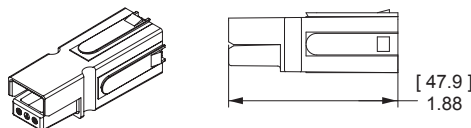

### PP75 Premate Ground Housings

Offers a first-mate, last-break connection when stacked together with PP75 housings. Stacks together with PP75 standard and chemical resistant housings. Housings are mechanically keyed to prevent cross mating with power positions.

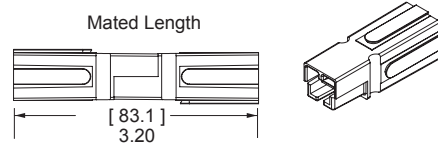

Description	----- Part Numbers -----	
Minimum Quantity...	1,000	100 ...
Green	5927G6-BK	5927G6

### PP75 Silver Plated Wire Contacts

Silver plated contacts offer the best electrical performance and durability up to 10,000 mating cycles. See reducing bushings in accessory section for smaller wires.

AWG	mm <sup>2</sup>	Mating Force	Loose Piece -- Part Numbers --		Dimensions - A - inches mm	
Minimum Quantity			1,000	100		
6	13.3	Low	1307-BK	1307	0.22	5.59
6	13.3	High	5900-BK	5900	0.22	5.59
8	8.4	High	5952-BK	5952	0.19	4.83
12 to 10	3.3 to 5.3	Low	5953-BK	5953	0.14	3.56
12 to 10	3.3 to 5.3	High	5915-BK	5915	0.14	3.56

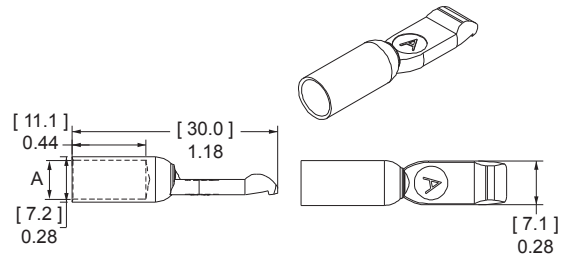

### PP75 Premate Ground Wire Contacts

Silver plated contacts for use with the PP75 Premate Ground Housing. Rated to 10,000 mating cycles.

Type	AWG	mm <sup>2</sup>	Loose Piece ----- Part Numbers -----		Dimensions - A - inches mm	
Minimum Quantity			1,000	100		
Individual	6	13.3	1875G1-BK	1875G1	0.22	5.59
Individual	8	8.4	1875G2-BK	1875G2	0.19	4.83
Individual	12 to 10	3.3 to 5.3	1875G3-BK	1875G3	0.14	3.56

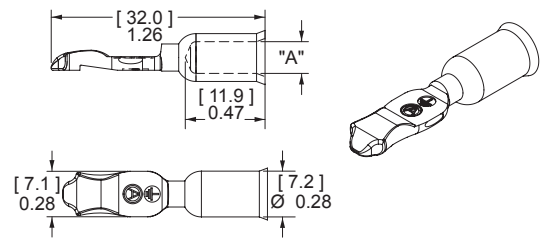

### PP75 Silver Plated Busbar Contacts

Provide a quick disconnect input or output busbar connection. Busbar contacts are for mating with wire contacts only. Part number 75BBS includes lock nuts. Locknuts must be ordered separately for B01915P1.

Type	Thread	Mating Force	----- Part Numbers -----		
Minimum Quantity			1,000	20	10 ...
Busbar	#10-24	High	B01915P1	-	75BBS
Lock Nut	#10-24	-	H1216P8	110G54	-

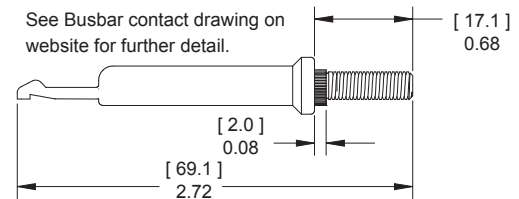

### 55A Right Angle Standard Powerclaw PCB Contacts

Standard Powerclaw contacts are for use inside a PP75 housing and provide a color coded right angle connection to the PCB.

Description	--- Loose Piece Part Numbers ---	
Minimum Quantity	500	100 .....
Tin Plated	PC5930T-BK	PC5930T
Silver Plated	PC5930S-BK	PC5930S

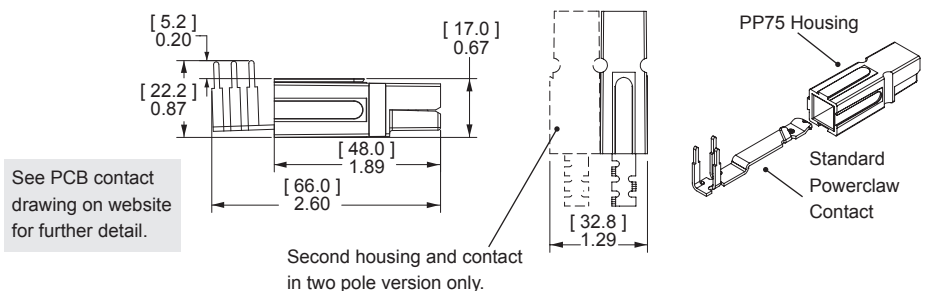

See PCB contact drawing on website for further detail.

Second housing and contact in two pole version only.

### 55A Right Angle Mini Powerclaw PCB Contacts

Right angle Mini Powerclaw contacts can be used on the PCB edge without a PP75 housing on the PCB side. A self polarizing design only allow PP75 wire housings to mate to PCB contacts one way.

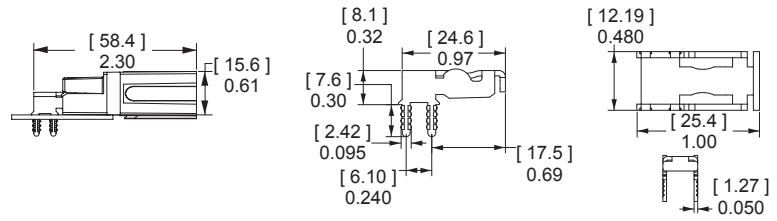

Description	Loose Piece	
	----- Part Numbers -----	
Minimum Quantity ...	1,000	100 .....
Tin Plated	PC5934T-BK	PC5934T
Silver Plated	PC5934S-BK	PC5934S

### 55A Vertical Mini Powerclaw PCB Contacts

Vertical Mini Powerclaw contacts save space by not requiring a PP75 housing on the PCB side. The guide housing is required for 2 pole applications to provide a polarized connection. (See PP75 accessories).

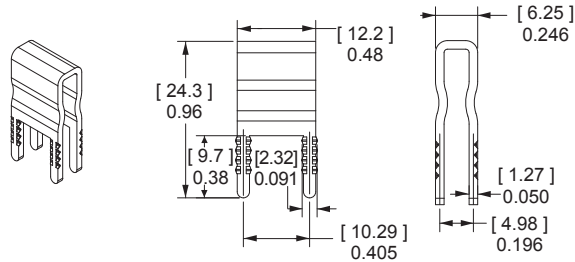

Description	Loose Piece	
	----- Part Numbers -----	
Minimum Quantity ...	1,500	100 .....
Tin Plated	PC5933T-BK	PC5933T
Silver Plated	PC5933S-BK	PC5933S

See PCB contact drawing on website for further detail.

## PP75 TEMPERATURE CHARTS

Temperature rise charts are based on a 25°C ambient temperature.

Current - Temperature Derating per IEC 60512-5-2 Test 5B

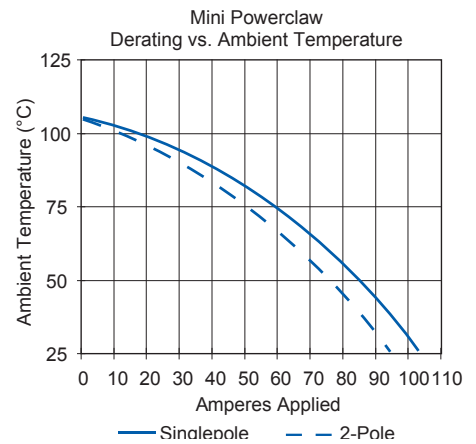
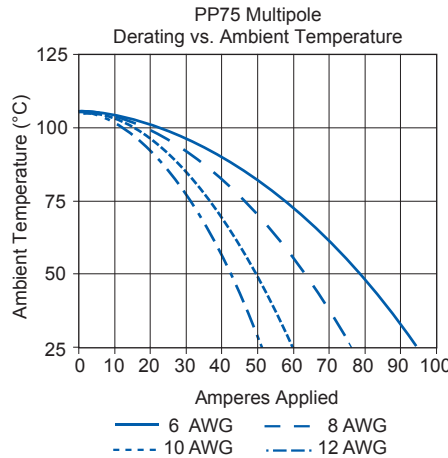
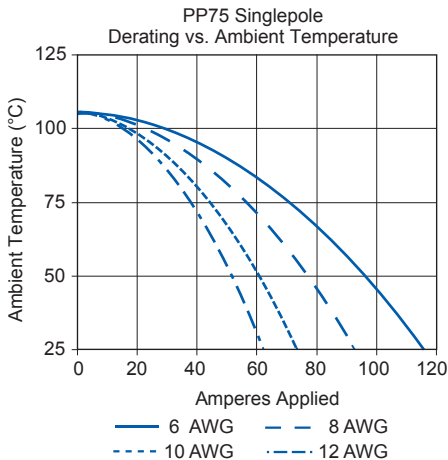

For Temperature Rise Above 60°C, Consult the Extended Temperature Rise Charts in the Appropriate Product Section on the Website.

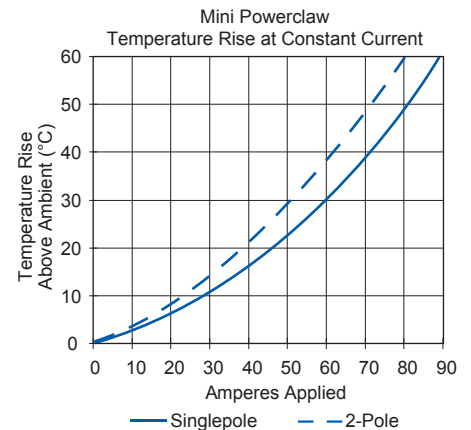
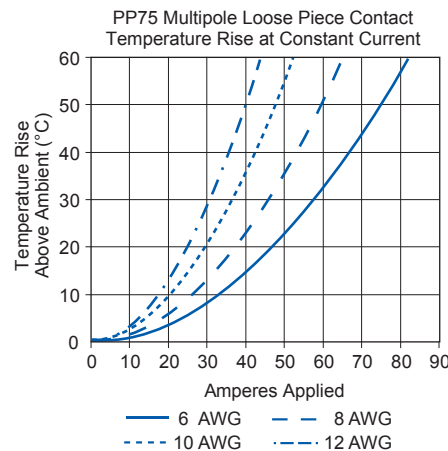
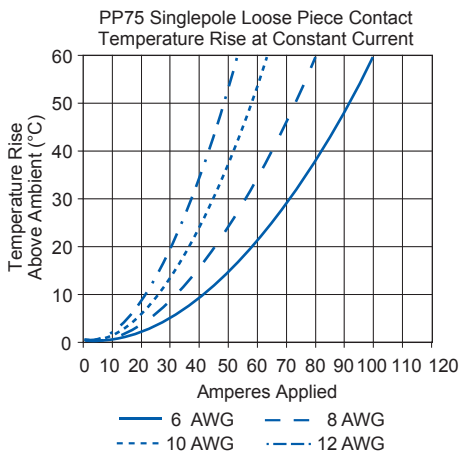

NOTE: Powerclaw charts are based on #8 AWG equivalent copper foil on board side, mated to #6 AWG conductor on wire side.

# PP75 SPECIFICATIONS |

Electrical		
<b>Current Rating Amperes <sup>1</sup></b>	<b>UL 1977</b>	<b>CSA</b>
Wire to Wire (6 AWG)	120	70
Wire to PCB (6-AWG)	55	50
Wire to Busbar (6 AWG)	75	
<b>Voltage Rating AC/DC</b>		
UL 1977	600	
<b>PCB Connector Recommended Voltage <sup>3</sup></b>		
<b>per IEC 60950-1 Table 2L Pollution Degree <sup>2</sup></b>		
Mini Vert. Contact Adjacent Poles	220	
Mini Horiz. Contact Adjacent Poles	200	
Standard Contact Adjacent Poles	635	
<b>Dielectric Withstanding Voltage</b>		
Volts AC	2,200	
<b>Avg. Mated Contact Resistance Milliohms <sup>1</sup></b>		
Wire Contact with 1 1/4" of #6 AWG	0.200	
PCB Contact to Contact	0.500	
<b>UL Hot Plug Current Rating Amperes - 250 cycles at 120V DC <sup>6</sup></b>		
Wire- wire	50A	
PCB- wire (Vertical Mini Powerclaw)	40A	
<b>UL Ground Short Time Current Test - 75A Premate Ground</b>		
1530 Amps, #6 AWG Wire	6 Seconds	

Materials	
<b>Housing</b>	
Standard Plastic Resin	Polycarbonate
Chem. Resistant Resin	Polycarbonate / PBT blend
Contact Retention Spring	Stainless Steel
<b>Housing Flammability Rating</b>	
UL94	V-0
Glow Wire	960°C (GWFI) / 800°C (GWIT)
<b>Contact</b>	
Base	Copper Alloy
Wire Plating	Silver
PCB Plating	Sn or Ag over Ni
<b>Contact Termination Methods</b>	
Crimp <sup>4</sup>	Wire Contacts
Hand Solder	Wire and PCB Contacts
Solder Dip*	PCB Contacts
Wave Solder*	PCB Contacts
Wrench / Socket	Busbar Contacts

Mechanical		
<b>Wire Size Range</b>	<b>AWG</b>	<b>mm<sup>2</sup></b>
Wire Contacts with Bushings	16 to 6	1.3 to 13.3
<b>Max. Wire Insulation Diameter</b>	<b>in.</b>	<b>mm</b>
	0.437	11.100
<b>Operating Temperature <sup>2</sup></b>	<b>°F</b>	<b>°C</b>
Standard & Ground	-4° to 221°	-20° to 105°
Chemical Resistant*	-40 to 221°	-40° to 105°
*Chemical resistant material not available for PCB guide housings		
<b>Mating Cycles No Load by Plating</b>	<b>Silver (Ag)</b>	<b>Tin (Sn)</b>
Wire and PCB Contacts	10,000	1,500
<b>Avg. Mating / Unmating Force</b>	<b>Lbf.</b>	<b>N</b>
Wire to Wire Low Force Contacts	5	22
Wire to Wire High Force Contacts	7	31
Standard Powerclaw to Wire	7	31
Mini Powerclaw to Wire	4	17
<b>PCB Specifications</b>		
Mounting Style	Plated Through Hole	
Max PCB Thickness- in. [mm]	Standard: 0.15 [0.381]	
	Mini: 0.25 [0.635]	
Recommended Traces	#8 AWG Cross Section	
<b>Min. Contact / Spring Retention Force</b>	<b>Lbf.</b>	<b>N</b>
Wire Housing	50	222
<b>Min. Creepage / Clearance Distance PCB in.</b>		<b>mm</b>
Standard Powerclaw Adjacent Poles	0.260	6.6
Mini Vert. Powerclaw Adjacent Poles	0.087	2.2
Mini Horiz. Powerclaw Adjacent Poles	0.079	2.0
<b>Mechanical Shock <sup>5</sup></b>		
MIL-STD-202	213 Condition A	50g's
<b>Vibration High Frequency <sup>5</sup></b>		
MIL-STD-202	204 Condition A	10g's

NOTE 1: See IEC 60664-1 for working voltage.

NOTE 2: Amp ratings are stated per position and based on all positions being fully loaded.

<sup>1</sup> Based on: 105°C rated or better cable of the largest size, Properly calibrated APP recommended tooling, and a 25°C ambient temperature. UL rating not to exceed the maximum operating temperature. CSA rating below a 30°C temperature rise.

<sup>2</sup> Limited by the thermal properties of the connector plastic housing.

<sup>3</sup> Without use of spacers to increase creepage and clearance distances.

<sup>4</sup> Use APP recommended tooling only. Alternate tools may adversely affect the performance of our connectors along with UL and CSA recognition.

<sup>5</sup> Tested with contact part number 5900.

<sup>6</sup> Based on 2 housings blocked together.



## | IEC INFORMATION |

Connector Series	Configurations		Creepage / Clearance per IEC 60950-1	Material Group
PP75	Single Pole	Unmated	2.97 mm	IIIa
		Mated	2.97 mm	
	Stacked Powerpole®	Unmated	2.97 mm	
		Mated	2.97 mm	

Attributes	PP75
AMP Rating AC/DC	75
Voltage Rating AC/DC (Steady State)	250 V AC/DC ( Operational)
Breaking Capacity -AMP Rating /Cycles	75 Amp / 10 Cycles
Voltage Rating (Breaking Capacity)	220 VDC
FINGER Safety - Mated only	IEC 60529 - IP20
Wire Size tested	16 mm <sup>2</sup>
Contact Series Tested	5900
Climatic Testing (Cold,Heat & MFG)	IEC 60512 Test -11j, 11i & 11g,
Cycle Life	IEC 60512 Test 9a - 5000 Cycles
Mechanical Strength Impact	IEC 60512-5 @ 29.5 Inches - dropped 8 times
Temperature Range	-20 °C to 105 °C -4 °F to 221 °F

Protection
<b>Touch Safety with Wire Contacts</b>
IEC 60529      IP10



NOTE 3: Refer to the Constructional Data form for additional information on our website., [www.andersonpower.com](http://www.andersonpower.com)

# POWERPOLE® PP75 ACCESSORIES |

## Strain Relief Grommets

Use for strain relief in the back side of a PP75 housing. Wire gauge given for reference only, use grommet ID and wire OD to determine suitability in the end application.

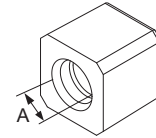

Description	- Part Numbers -	Dimensions	
		- A - inches mm	
Minimum Quantity ...	100	.....	
#6 AWG, Black	114411P2	0.35	8.89
#8 AWG, Black	114411P1	0.25	6.35
#10 - 12 AWG, Black	114411P3	0.17	4.32

## Mounting Wing for Standard or CR Housings

Mounting wings can be used to secure dovetailed Powerpole® 75 series housings by passing fasteners through the wings in either a horizontal or vertical orientation. Useful for sheet metal panels, printed circuit boards, and many other mounting surfaces. Fasteners not included.

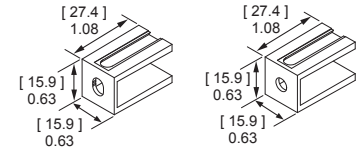

Description	----- Part Numbers -----	
Minimum Quantity ...	1,000	100 ...
Blue, Round Hole	1399G20-BK	1399G20
Blue, Oval Hole	1399G7-BK	1399G7

## Mounting Wing for Locking Housings

Mounting wings can be used to secure Powerpole® 75 series housings with locking dovetails by passing fasteners through the wings in either a horizontal or vertical orientation. Useful for sheet metal panels, printed circuit boards, and many other mounting surfaces. Fasteners not included.

Description	----- Part Numbers -----	
Minimum Quantity ...	1,000	100 ...
Blue, Oval Hole	75LOKWNGBLU-BK	75LOKWNGBLU
Blue, Round Hole	75LOKWNGBLU-R-BK	75LOKWNGBLU-R

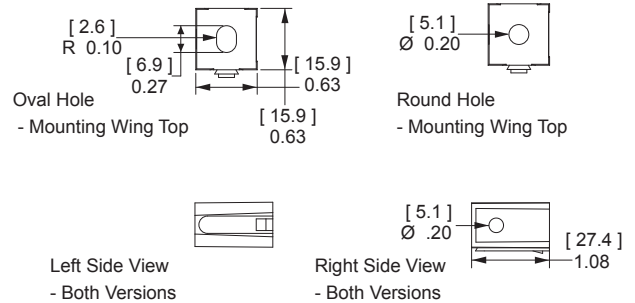

## Surface Mount for Locking Housings

Use to secure Powerpole® 75 series housings with locking dovetails to a flat surface. Useful for sheet metal panels, printed circuit boards, and many other mounting surfaces. Fasteners not included.

Description	----- Part Numbers -----	
Minimum Quantity ...	1,000	100 ...
Blue	75LOKSMTBLU-BK	75LOKSMTBLU

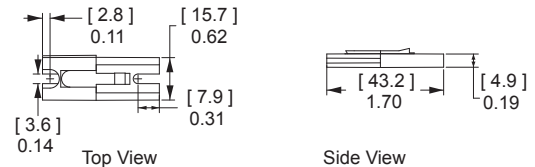

## Spacer

Use to separate housings under high power to minimize power capability derating due to heat rise. They are recommended for squaring off a block of Powerpole® 75 housings to enable mounting accessories or retaining pins to be used. Combining long and short spacers opposite each other in a mated block adds keying features, or use two short spacers to avoid interference.

Description	----- Part Numbers -----	
Minimum Quantity...	1000	100 ....
Red, Short	1399G23-BK	1399G23
Red, Long	1399G21-BK	1399G21

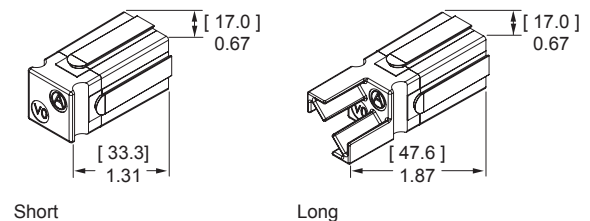

### Guide Housings for Vertical Mini Powerclaw Contacts

Prevents polarity being reversed when a two pole PP75 block is mated to vertical mini Powerclaw contacts. Fastening hardware not included.

Description	Part Numbers	
Minimum Quantity ...	1,000	100 ...
Black Guide Housing	PC-HSG-PP-BK	PC-HSG-PP

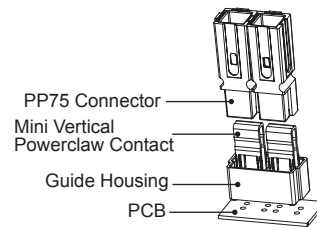

### Mounting Clamp

Mounting clamps can be used for fastening a block of Powerpole® 75 series housings to a panel. Connector blocks must be a complete square for the clamps to work properly. Fastening hardware not included.

Description	Part Numbers	
Minimum Quantity ...	50 sets of 2 ...	
2 or 4 Pole	1463G1	
3 or 6 Pole	1463G2	

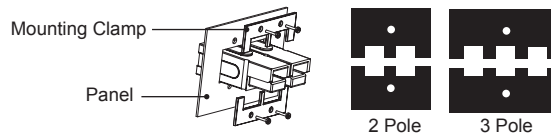

### Retaining Pins

Retaining pins are used to keep stacked Powerpole® 75 series housings from separating. Retaining pins are inserted in the circular opening between two housings stacked side by side. Dimension B is +/- 0.015 in or 0.38 mm.

Description	Part Numbers		Dimensions			
			- A -		- B -	
Minimum Quantity ...	1,000	100	inches	mm	inches	mm
1 Block High	111812P7	110G19	0.196 / 0.207	4.98 / 5.26	0.560	14.220
2 Block High	111812P6	110G18	0.196 / 0.207	4.98 / 5.26	1.000	25.400

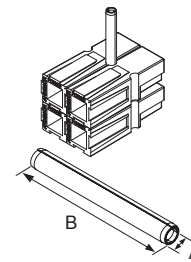

### PCB Mounting Staples

Reduce strain on solder joints during mating and unmating. Staples bend over the underside of the PCB board to lock the housings in place. Staples are an interference fit with housings.

Part Numbers	Number of Stacked Powerpoles® H x W
Minimum Quantity .....	100 .....
PCSTAPLE-2	1 x 2

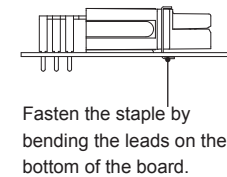
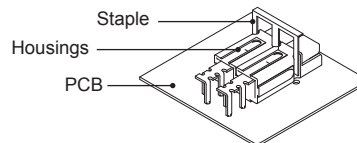

Slide staple over housings and into the holes in the board.

### Reducing Bushings

Use with contact part number 5900-BK or 1307-BK to allow a smaller wire to be used with the connector. Electrical capability is derated with smaller wire.

Contact Barrel Size	Wire Size	Part Numbers			Dimensions			
		3,000	1,000	100	- ID -		- Length -	
Minimum Quantity					inches	mm	Inches	mm
#6 AWG [13.3 mm²]	#8 AWG [8.4 mm²]	-	5912-BK	5912	0.18	4.57	0.45	11.43
#6 AWG [13.3 mm²]	#12- 10 AWG [3.3- 5.3 mm²]	5910-BK	-	5910	0.14	3.56	0.47	11.94
#6 AWG [13.3 mm²]	#16- 14 AWG [1.3- 2.1 mm²]	5913-BK	-	5913	0.09	2.29	0.47	11.94

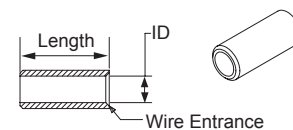

For environmentally sealed connector shells to hold Powerpole® 15-180 connectors, see SPEC Pak® product series on our website, [www.andersonpower.com](http://www.andersonpower.com)



# Powerpole®

## - Tooling Information

Wire Size		Reeled Part Numbers		Reeled Contact Crimp Tool	
AWG	mm²	Tin Plating	Silver Plating	APP Applicator +	APP Press
<b>PP15 / 45 Flat Wiping Power &amp; Ground</b>					
#16 / 20	1.3 / 0.52	262G1	262G2	TD0101	115V= TE0101 230V = TE0102
#16 / 20	1.3 / 0.52	269G2	N/A		
#12 / 16	3.3 / 1.3	261G1	N/A		
#10 / 14	5.3 / 2.1	261G2	261G3		
#12 / 16	3.3 / 1.3	269G1	N/A		
#10 / 14	5.3 / 2.1	269G3	N/A		
#10 / 14	5.3 / 2.1	200G1L	200G3L	TD0102	
#10 / 14	5.3 / 2.1	201G1H	N/A		
#10 / 14	5.3 / 2.1	1830G1	1830G2		

\* APP applicators are mechanical feed style and do not require an air feed kit.

Wire Size		Loose Piece Part Numbers		Loose Piece Contact Crimp Tool				
AWG	mm²	Tin Plating	Silver Plating	Hand Tool Or	Pneumatic Bench Tool +	Die +	Locator	Number of Crimps
<b>PP15 / 45 Flat Wiping Power &amp; Ground</b>								
#16 / 20	1.3 / 0.52	N/A	1332	1309G2 or 1309G8	N/A	N/A	N/A	Single
#12 / 16	3.3 / 1.3	N/A	1331					
#16 / 20	1.3 / 0.52	262G1-LPBK	262G2-LPBK					
#16 / 20	1.3 / 0.52	269G2-LPBK	N/A	1309G3 or 1309G8	N/A	N/A	N/A	Single
#12 / 16	3.3 / 1.3	261G1-LPBK	N/A					
#10 / 14	5.3 / 2.1	261G2-LPBK	261G3-LPBK					
#12 / 16	3.3 / 1.3	269G1-LPBK	N/A	1309G6 or 1309G8	N/A	N/A	N/A	Single
#10 / 14	5.3 / 2.1	269G3-LPBK	N/A					
#10 / 14	5.3 / 2.1	200G1L-LPBK	200G3L-LPBK					
#10 / 14	5.3 / 2.1	201G1H-LPBK	N/A	1309G6 or 1309G8	N/A	N/A	N/A	Single
310 / 14	5.3 / 2.1	1830G1-LPBK	1830G2-LPBK					
<b>PP75</b>								
#6	13.3	N/A	1307	1309G4	1387G1	1388G6	1389G6	Single
			5900				1389G21	
#8	8.4		1875G1				1389G6	
			5952				1389G21	
			1875G2				1389G21	
			5953				1389G6	
#10 / 12	5.3 / 3.3		5915				1389G21	
			1875G3				1389G21	
<b>PP120</b>								
1/0	53.5	N/A	1323G2	1368 Series	1387G1	1388G3	1389G4	Single
#1	42.4		1323G1					
#2	33.6		1319					
#4	21.2		1319G4					
#6	13.3		1319G6					
<b>PP180</b>								
3/0	85	N/A	1328G2	1368 Series	1387G2	1303G12	1304G32	Double
2/0	53.5		1328G1					
1/0	53.5		1382					
#1	42.4		1347					
#2	33.6		1383					
#4	21.1		1384					
#6	13.3		1348					
						1387G1		

- NOTE: See website for the most current information.
- NOTE: Insertion / Extraction tool for PP15/45 contacts = 111038G2



# Mouser Electronics

Authorized Distributor

Click to View Pricing, Inventory, Delivery & Lifecycle Information:

## Anderson Power Products:

[1307](#) [1307-BK](#) [5900](#) [5910](#) [5910-BK](#) [5912](#) [5912-BK](#) [5913](#) [5915](#) [5952](#) [5952-BK](#) [5953](#) [5953-BK](#) [75BBS](#)  
[pc5930s](#) [PC5930T](#) [PC5934S](#) [114411p1](#) [114411p2](#) [114411p3](#) [1399g20-bk](#) [1399G7-BK](#) [75LOKBLU](#) [75LOKGRA](#)  
[75LOKGRN](#) [75LOKRED](#) [75LOKSMTBLU](#) [75LOKWHT](#) [75LOKWNGBLU-R](#) [PC-HSG-PP-BK](#) [PCSTAPLE-1](#)  
[PCSTAPLE-2](#) [PC5930S-BK](#) [PC5930T-BK](#) [75LOKBLK-BK](#) [75LOKSMTBLU-BK](#) [75LOKGRA-BK](#) [75LOKWNGBLU-BK](#)  
[75LOKGRN-BK](#) [75LOKWNGBLU-R-BK](#) [75LOKRED-BK](#) [75LOKBLU-BK](#) [75LOKWHT-BK](#) [P5916-BK](#) [P5916G5-BK](#)  
[P5916G7-BK](#) [P5916G4-BK](#) [1399G23-BK](#) [1399G23](#) [1875G3](#) [1875G1](#) [5927G6](#) [5927G6-BK](#) [1875G2](#) [1875G1-BK](#)  
[1875G3-BK](#) [1875G2-BK](#) [B01915P1](#) [1399G21-BK](#) [1399G21](#)