

Skirting LED Lighting Profile ~ Model SKIRT10

SKIRT10AC2/Q9

- elegant and robust skirting board for LED strips
- soft glow with a 60 P/M. LED strip
- optimum light effect with a matt floor or carpet
- convenient installation
- space to hide cables

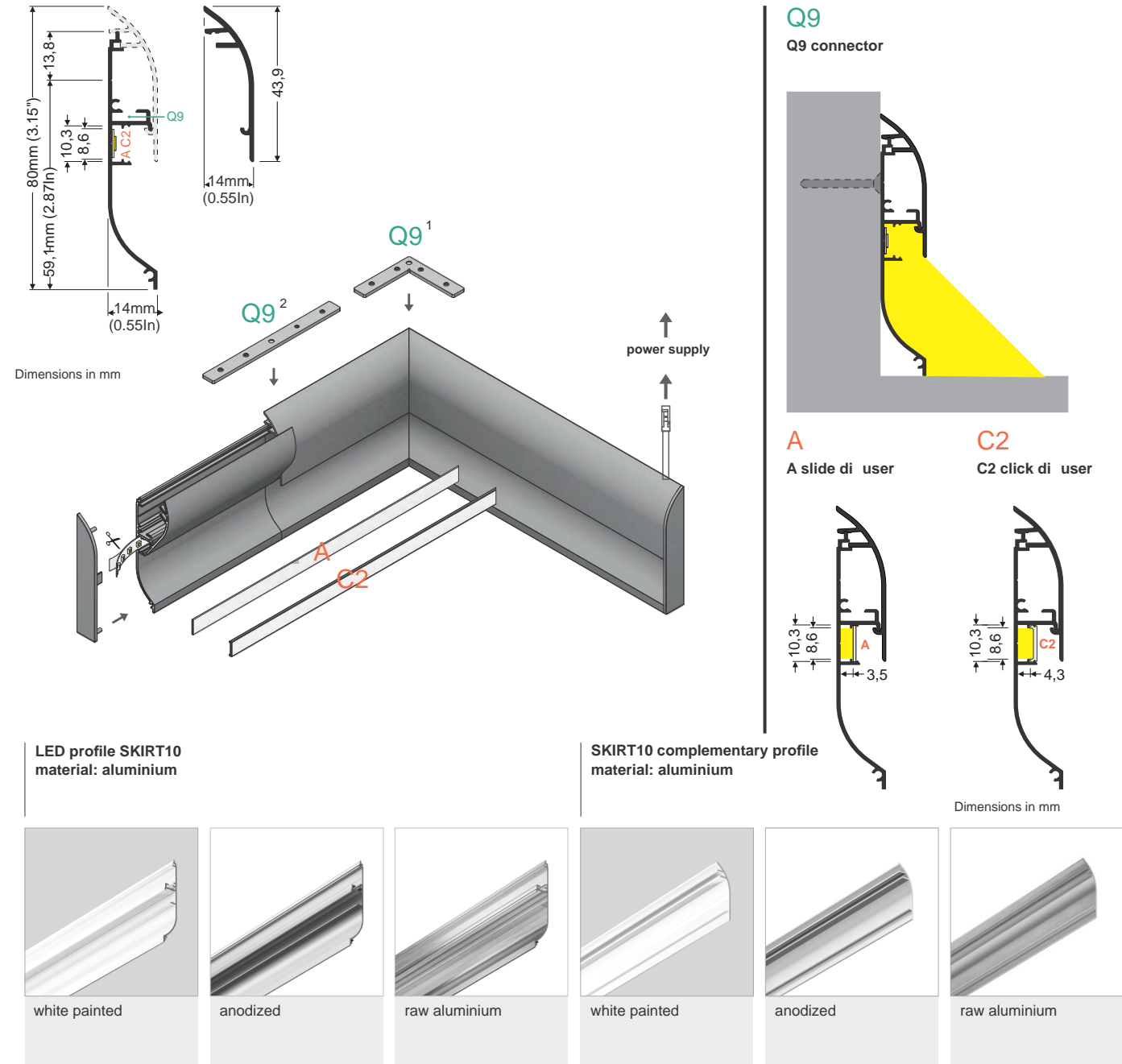
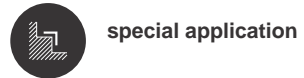

* Parameters tolerance +/- 7%

Covers

A A slide cover

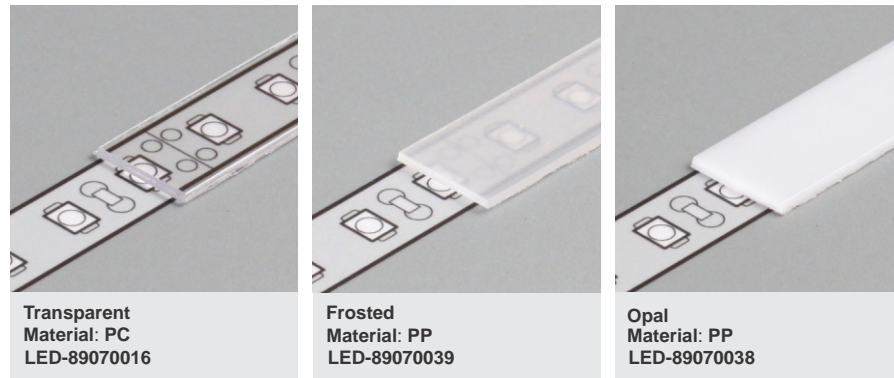
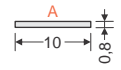

Transparent
Material: PC
LED-89070016

Frosted
Material: PP
LED-89070039

Opal
Material: PP
LED-89070038

Dimensions in mm

C2 C2 click cover

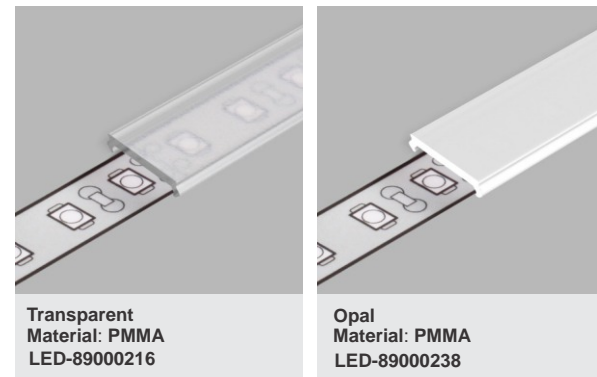
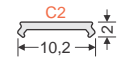

Transparent
Material: PMMA
LED-89000216

Opal
Material: PMMA
LED-89000238

Dimensions in mm

Q9 Connectors (1 piece including screws)

Q9¹ Q9-90 deg connector bent material: zinc coated steel

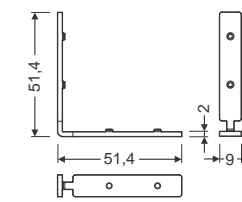

LED-V5999519s

Q9² Q9-180 deg connector material: zinc coated steel

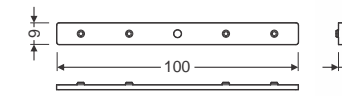

LED-V5999819s

Q9³ Q9-135 deg connector material: zinc coated steel

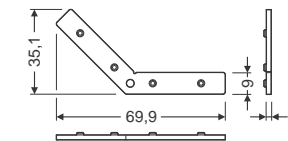

V5999719s

Q9⁴ Q9-120 deg connector material: zinc coated steel

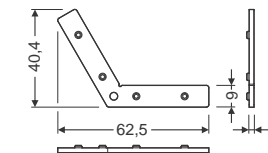

LED-V5999619s

Q9⁵ Q9-90 deg connector material: zinc coated steel

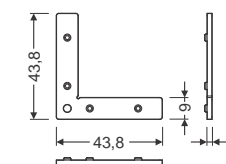

LED-V5999419s

Q9⁶ Q9-60 deg connector material: zinc coated steel

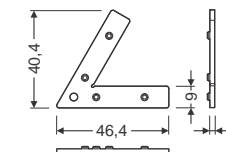

LED-V5999319s

Q9⁷ Q9-45 deg connector material: zinc coated steel

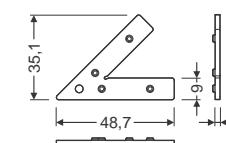

LED-V5999219s

Q9 SLINGS ELEMENTS

Q9 holder for sling
material: zinc coated steel



LED-V5999919s

screw for Q9 connector



LED-V5998830